

TGS 8100 - for the detection of Air Contaminants

Features:

- * Surface mount package
- * Low power consumption
- * High sensitivity to cigarette smoke, cooking odors, and gaseous air contaminants
- * Long life
- * Low cost

Applications:

- * Indoor air quality monitors
- * Air cleaners
- * Ventilation control
- * Kitchen range hood control

The sensing element is comprised of a sensing chip and an integrated heater formed on a silicon substrate using MEMS technology, and a metal-oxide semiconductor layer formed on the sensing chip. The device is housed in a surface-mount ceramic package. Due to miniaturization of the sensing chip, **TGS 8100** requires a heater power consumption of only 15mW, and is suitable for low-power equipment and battery-operated instruments. In the presence of detectable gas, sensor conductivity increases depending on gas concentration in the air. A simple electrical circuit can convert the change in conductivity to an output signal which corresponds to the gas concentration.

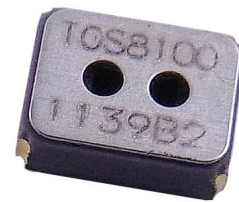

The **TGS 8100** has high sensitivity to low concentrations of gaseous air contaminants such as cigarette smoke and cooking odors. By utilizing the change ratio of sensor resistance from the resistance in clean air as relative response, human perception of air contaminants can be simulated and practical air quality control can be achieved.

The figure below represents typical sensitivity characteristics, all data having been gathered at standard test conditions (see reverse side of this sheet). The Y-axis is indicated as sensor resistance ratio (R_s/R_o) which is defined as follows:

- R_s = Sensor resistance in displayed gases at various concentrations
- R_o = Sensor resistance in fresh air

The figure below represents typical temperature and humidity dependency characteristics. Again, the Y-axis is indicated as sensor resistance ratio (R_s/R_o), defined as follows:

- R_s = Sensor resistance in fresh air at various temperatures/humidities
- R_o = Sensor resistance in fresh air at 20°C and 65% R.H.

Sensitivity Characteristics:

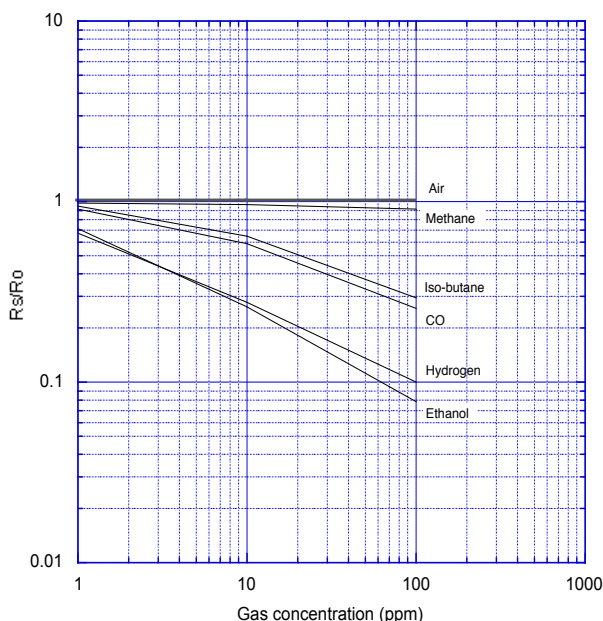

Temperature/Humidity Dependency:

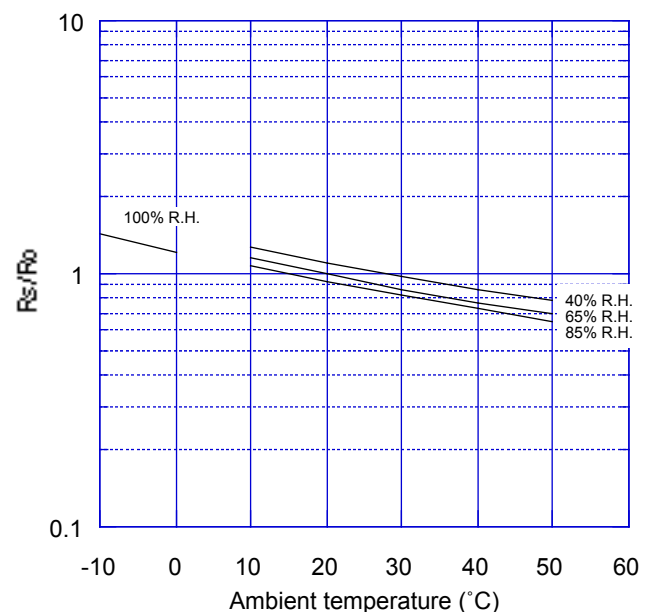

IMPORTANT NOTE: OPERATING CONDITIONS IN WHICH FIGARO SENSORS ARE USED WILL VARY WITH EACH CUSTOMER'S SPECIFIC APPLICATIONS. FIGARO STRONGLY RECOMMENDS CONSULTING OUR TECHNICAL STAFF BEFORE DEPLOYING FIGARO SENSORS IN YOUR APPLICATION AND, IN PARTICULAR, WHEN CUSTOMER'S TARGET GASES ARE NOT LISTED HEREIN. FIGARO CANNOT ASSUME ANY RESPONSIBILITY FOR ANY USE OF ITS SENSORS IN A PRODUCT OR APPLICATION FOR WHICH SENSOR HAS NOT BEEN SPECIFICALLY TESTED BY FIGARO.

Basic Measuring Circuit:

The sensor requires two voltage inputs: heater voltage (V_H) and circuit voltage (V_C). The heater voltage (V_H) is applied to the integrated heater in order to maintain the sensing element at a specific temperature which is optimal for sensing. Circuit voltage (V_C) is applied to allow measurement of voltage (V_{OUT}) across a load resistor (R_L) which is connected in series with the sensor. DC voltage is required for the circuit voltage since the sensor has a polarity.

The value of the load resistor (R_L) should be chosen to optimize the alarm threshold value.

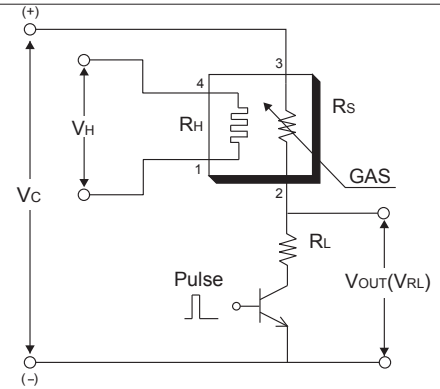

Specifications (tentative):

Model number		TGS8100	
Sensing principle		MOS type	
Standard package		Ceramic	
Target gases		Air contaminants (hydrogen, ethanol, etc.)	
Typical detection range		1 ~ 30ppm H ₂	
Standard circuit conditions	Heater voltage	V_H	1.8V DC \pm 2%
	Circuit voltage	V_C	max 3.0V DC for 2msec 0v \geq 998msec
	Load resistance	R_L	variable (10k Ω min.)
Electrical characteristics under standard test conditions	Heater resistance	R_H	approx. 110 Ω at room temp.
	Heater current	I_H	8mA (typical)
	Heater power consumption	P_H	15mW (typical)
	Sensor resistance	R_S	10k Ω ~ 300k Ω in air
	Sensitivity (change ratio of R_S)		~0.6
Standard test conditions	Test gas conditions	normal air at 20 \pm 2 $^\circ$ C, 65 \pm 5%RH	
	Circuit conditions	same as std circuit conditions	
	Conditioning period before test	1 hour or longer	

Sensor resistance (R_S) is calculated with a measured value of $V_{OUT}(V_{RL})$ by using the following formula:

$$R_S = \left(\frac{V_C}{V_{RL}} - 1 \right) \times R_L$$

NOTE: TGS8100 is an ESD-sensitive device. Figaro recommends using ESD protection equipment for handling the sensor.

All sensor characteristics shown in this brochure represent typical characteristics. Actual characteristics vary from sensor to sensor. The only characteristics warranted are those in the Specification table above.

REV: 03/14

Structure and Dimensions:

Top view

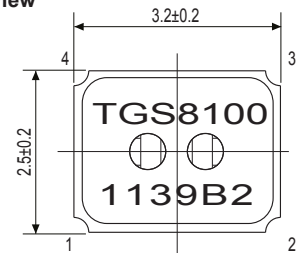

Side view

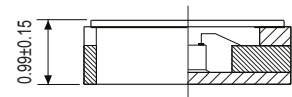

Bottom View

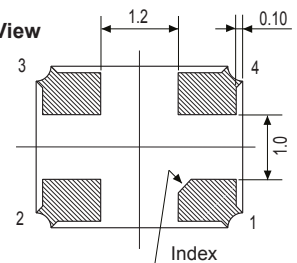

u/m = mm

Pin connections:

- 1: Heater
- 2: Sensor electrode (-)
- 3: Sensor electrode (+)
- 4: Heater