

FIGARO

an ISO9001 and 14001 company

Technical Information for Methane Gas Sensors

The Figaro 2600 series is a new type thick film metal oxide semiconductor, screen printed gas sensor which offers miniaturization and lower power consumption. The TGS2611 displays high selectivity and sensitivity to methane.



Page

Specifications

Features.....2
 Applications.....2
 Structure.....2
 Basic Measuring Circuit.....2
 Circuit & Operating Conditions.....3
 Specifications.....3
 Dimensions.....3

Basic Sensitivity Characteristics

Sensitivity to Various Gases.....4
 Temperature and Humidity Dependency.....5
 Heater Voltage Dependency.....6
 Cautions on Sensor Power Consumption.....6
 Gas Response.....7
 Initial Action.....7
 Long Term Characteristics.....8

Reliability

Corrosion Test.....9
 Ignition Test.....9
 Effect of Air Flow.....9
 Heater Resistance Durability.....10
 HMDS Test.....11
 Lighter Gas Exposure Test.....11

Cautions.....12

See also Technical Brochure ‘Technical Information on Usage of TGS Sensors for Toxic and Explosive Gas Leak Detectors’.

IMPORTANT NOTE: OPERATING CONDITIONS IN WHICH FIGARO SENSORS ARE USED WILL VARY WITH EACH CUSTOMER’S SPECIFIC APPLICATIONS. FIGARO STRONGLY RECOMMENDS CONSULTING OUR TECHNICAL STAFF BEFORE DEPLOYING FIGARO SENSORS IN YOUR APPLICATION AND, IN PARTICULAR, WHEN CUSTOMER’S TARGET GASES ARE NOT LISTED HEREIN. FIGARO CANNOT ASSUME ANY RESPONSIBILITY FOR ANY USE OF ITS SENSORS IN A PRODUCT OR APPLICATION FOR WHICH A SENSOR HAS NOT BEEN SPECIFICALLY TESTED BY FIGARO.



Both TGS2611-C00 and -E00 are UL recognized components in accordance with the requirements of UL2075. Please note that component recognition testing has confirmed long term stability in 60ppm of methane; other characteristics shown in this brochure have not been confirmed by UL as part of component recognition.

TGS2611 is available in two different models with different external housings but identical sensitivity to methane gas. TGS2611-C00 possesses small size and quick gas response, making it suitable for gas leakage checkers, while TGS2611-E00 uses filter material in its housing to eliminate the influence of interference gases such as alcohol, resulting in highly selective response to methane gas. Both models are capable of meeting the requirements of EN50194 and UL1484.

1. Specifications

1-1 Features

- * High selectivity to methane
- * Low power consumption
- * Small size
- * Long life and low cost
- * Uses simple electrical circuit

1-2 Applications

- * Residential gas alarms
- * Portable gas detectors
- * Gas leak detectors for gas appliances

1-3 Structure

Figure 1 shows the structure of TGS2611. Using thick film techniques, the sensing material (SnO₂) is printed on electrodes (noble metal) which have been printed onto an alumina substrate. One electrode is connected to pin No.2 and the other is connected to pin No.3. The sensor element is heated by RuO₂ material printed onto the reverse side of the substrate and connected to pins No.1 and No.4.

Lead wires are Pt-W alloy and are connected to sensor pins which are made of Ni-plated Ni-Fe 50%.

The sensor base is made of Ni-plated steel. The caps of both TGS2611-C00 and TGS2611-E00 are stainless steel. The upper opening in both caps is covered with a double layer of 100 mesh stainless steel gauze (SUS316). The TGS2611-E00 utilizes a charcoal filter inside the cap for reducing the influence of interference gases.

1-4 Basic measuring circuit

Figure 2 shows the basic measuring circuit. Circuit voltage (V_C) is applied across the sensor element which has a resistance (R_S) between the sensor's two electrodes and the load resistor (R_L) connected in series. When DC is used for V_C, the polarity shown in Figure 2 **must** be maintained. The V_C may be applied intermittently. The sensor signal (V_{RL}) is measured indirectly as a change in voltage across the R_L. The R_S is obtained from the formula shown at the right.

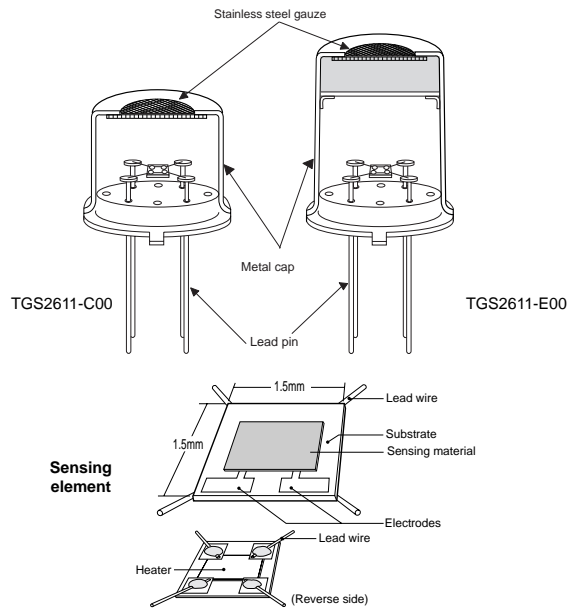

Fig. 1 - Sensor structure

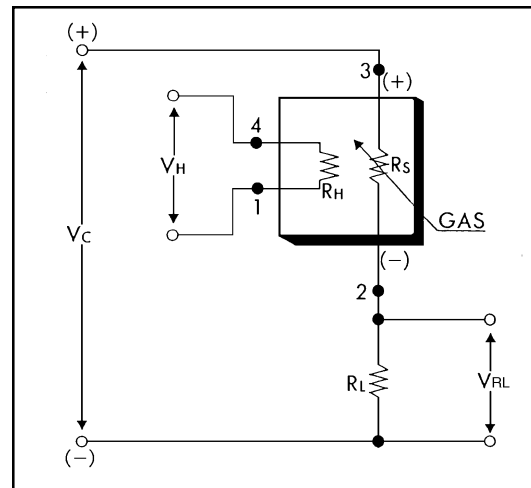

Fig. 2 - Basic measuring circuit

NOTE: In the case of V_H, there is no polarity, so pins 1 and 4 can be considered interchangeable. However, in the case of V_C, when used with DC power, pins 2 and 3 must be used as shown in the Figure above.

$$R_s = \frac{V_C - V_{RL}}{V_{RL}} \times R_L$$

Formula to determine R_S

1-5 Circuit & operating conditions

The ratings shown below should be maintained at all times to insure stable sensor performance:

Item	Specification
Circuit voltage (Vc)	5.0V ± 0.2V DC/AC
Heater voltage (VH)	5.0V ± 0.2V DC/AC
Inrush heater current (VH=5.0V)	100mA max.
Heater resistance (room temp.)	approx. 59Ω
Load resistance (RL)	variable (0.45kΩ min.)
Sensor power consumption (Ps)	≤ 15mW
Operating & storage temperature	-40°C ~ +70°C
Optimal detection concentration	500 ~ 10,000ppm

1-6 Specifications NOTE 1

Item	Specification
Sensor resistance (5000ppm methane)	0.68kΩ ~ 6.8kΩ
Sensor resistance gradient (β)	0.60 ± 0.06
$\beta = R_s(9000\text{ppm methane})/R_s(3000\text{ppm methane})$	
Heater current	56 ± 5mA
Heater power consumption	280 ± 25mW

NOTE 1: Sensitivity characteristics are obtained under the following standard test conditions:

(Standard test conditions)

Temperature and humidity: 20 ± 2°C, 65 ± 5% RH

Circuit conditions: Vc = 5.0±0.01V DC

VH = 5.0±0.05V DC

RL = 10.0kΩ ± 1%

Preheating period: 7 days or more under standard circuit conditions.

All sensor characteristics shown in this brochure represent typical characteristics. Actual characteristics vary from sensor to sensor and from production lot to production lot. The only characteristics warranted are those shown in the Specification table above.

1-7 Dimensions

TGS2611-C00

TGS2611-E00

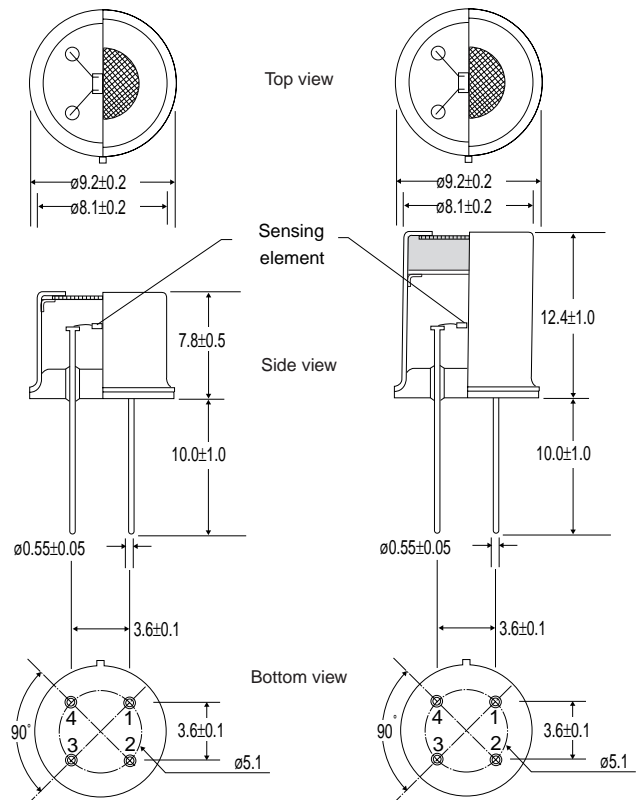

Pin connection:
 1: Heater
 2: Sensor electrode (-)
 3: Sensor electrode (+)
 4: Heater

Fig. 3 - Sensor dimensions

Mechanical Strength:

The sensor shall have no abnormal findings in its structure and shall satisfy the above electrical specifications after the following performance tests:

Withdrawal Force - withstand force of 5kg in each direction (pin from base)

Vibration - frequency-1000cycles/min., total amplitude-4mm, duration-one hour, direction-vertical

Shock - acceleration-100G, repeated 5 times

2. Basic Sensitivity Characteristics

2-1 Sensitivity to various gases

Figure 4a and 4b show the relative sensitivity of TGS2611 to various gases. The Y-axis shows the ratio of the sensor resistance in various gases (R_s) to the sensor resistance in 5000ppm of methane (R_o).

For TGS2611-C00, the sensitivity to ethanol, which may act as an interference gas, is lower compared with that of methane. However, TGS2611-E00 shows significantly less sensitivity to alcohol than TGS2611-C00 while showing no significant difference in sensitivity to methane.

Using the basic measuring circuit illustrated in Fig. 2, and with a matched RL value equivalent to the R_s value in 5000ppm of methane will provide sensor output voltage (VRL) change as shown in Figure 5.

NOTE:

All sensor characteristics in this technical brochure represent typical sensor characteristics. Since the R_s or output voltage curve varies from sensor to sensor, calibration is required for each sensor (for additional information on calibration, please refer to the Technical Advisory 'Technical Information on Usage of TGS Sensors for Toxic and Explosive Gas Leak Detectors').

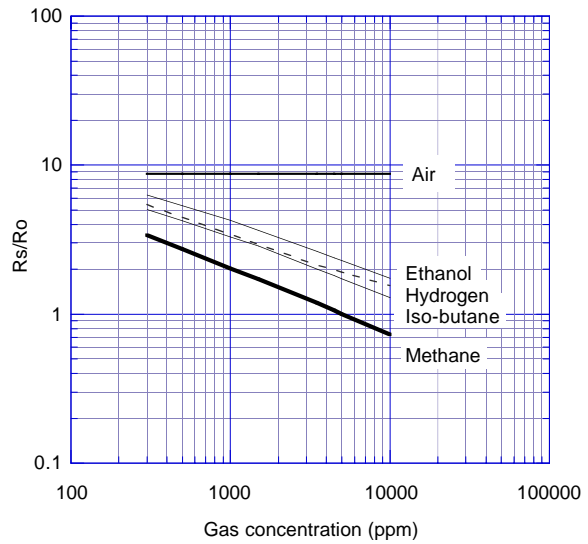

Fig. 4a - Sensitivity to various gases (R_s/R_o) of TGS2611-C00

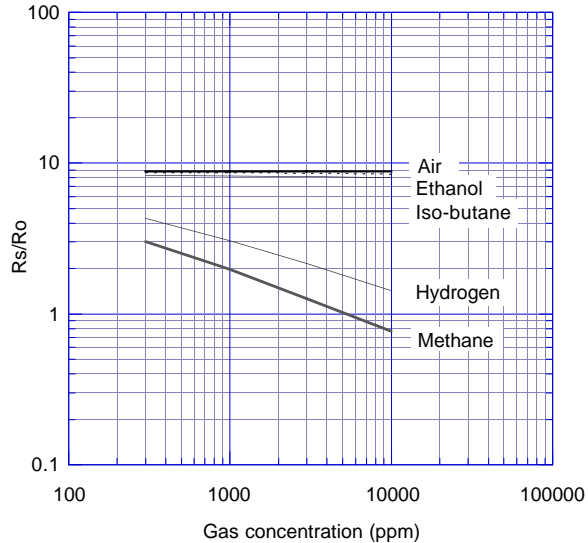

Fig. 4b - Sensitivity to various gases (R_s/R_o) of TGS2611-E00

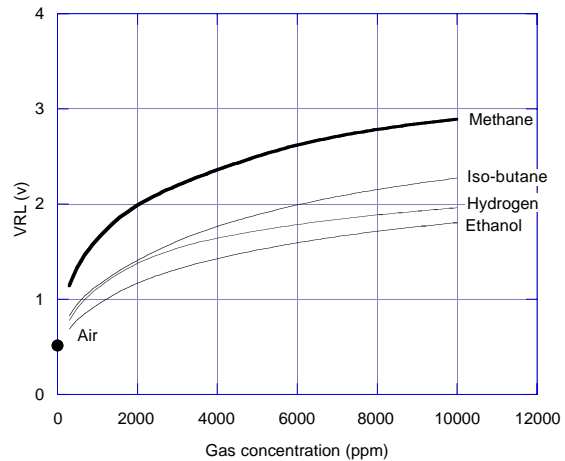

Fig. 5 - Sensitivity to various gases (VRL) of TGS2611-C00

2-2 Temperature and humidity dependency

Figure 6 shows the temperature and humidity dependency of TGS2611. The Y-axis shows the ratio of sensor resistance in 5000ppm of methane under various atmospheric conditions (R_s) to the sensor resistance in 5000ppm of methane at 20°C/65%RH (R_o).

R.H. (°C)	35%R.H.	50%R.H.	65%R.H.	95%R.H.
-10				1.51
0			1.45	1.25
10		1.33	1.19	1.02
20	1.25	1.11	1.00	0.87
30	1.05	0.94	0.86	0.77
40	0.92	0.82	0.76	0.69

Table 1 - Temperature and humidity dependency (typical values of R_s/R_o for Fig. 6)

Table 1 shows a table of values of the sensor's resistance ratio (R_s/R_o) under the same conditions as those used to generate Figure 6.

Figure 7 shows the sensitivity curve for TGS2611 to methane under several ambient conditions. While temperature may have a large influence on absolute R_s values, this chart illustrates the fact that effect on the slope of sensor resistance ratio (R_s/R_o) is not significant. As a result, the effects of temperature on the sensor can easily be compensated.

For economical circuit design, a thermistor can be incorporated to compensate for temperature (for additional information on temperature compensation in circuit designs, please refer to the Technical Advisory 'Technical Information on Usage of TGS Sensors for Toxic and Explosive Gas Leak Detectors').

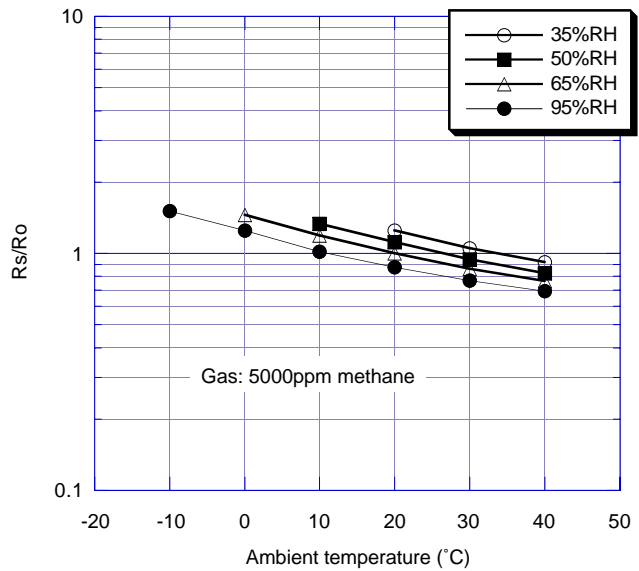

Fig. 6 - Temperature and humidity dependency (R_s/R_o)

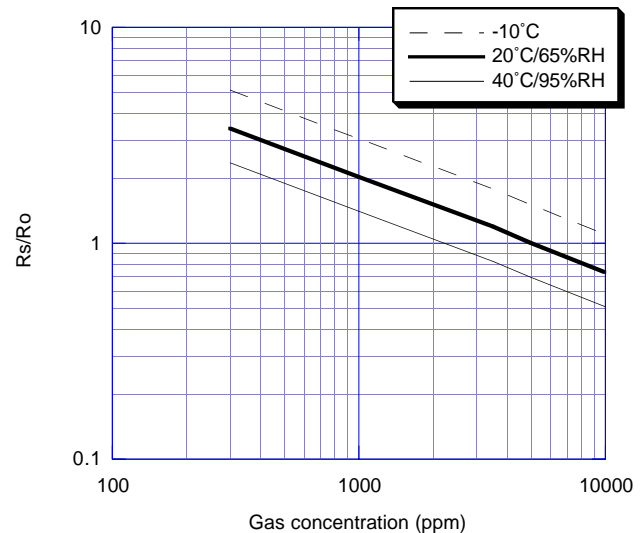

Fig. 7 - Resistance change ratio under various ambient conditions

2-3 Heater voltage dependency

Figure 8 shows the change in the sensor resistance ratio according to variations in heater voltage (VH). Note that 5.0V as a heater voltage must be maintained because variance in applied heater voltage will cause the sensor's characteristics to be changed from the typical characteristics shown in this brochure.

2-4 Cautions on sensor power consumption

Figure 9 shows the typical relationship between sensor voltage (Vs) and sensor current (Is) for TGS2611 in various gas concentration. This relationship is referred to as V-I characteristics.

When circuit voltage is applied to the sensor in the basic measuring circuit (see Figure 2), Joule heat is generated by the sensor current. The amount of Joule heat is equivalent to sensor power consumption (Ps) and can be calculated according as follows:

$$P_s = \frac{V_{RL} \times (V_c - V_{RL})}{R_L}$$

where: RL : Load resistor value (kΩ)
 VRL: Sensor output voltage (v)
 Vc : Circuit voltage (v)
 Ps : Power consumption (mW)

The maximum sensor power consumption value is $V_c^2 / (4 \times R_L)$ when sensor output voltage is $V_c / 2$.

According to the V-I characteristics shown in Fig. 9, if Ps exceeds 15mW, the sensor would deviate from Ohmic behavior, thus altering its characteristics from those shown as typical in this brochure. Also, excess sensor power consumption may cause permanent damage to the sensor due to Joule heat.

To protect the sensor against deviating from Ohmic behavior, please refer to Table 2 for suggested minimum RL values according to the user's circuit voltage.

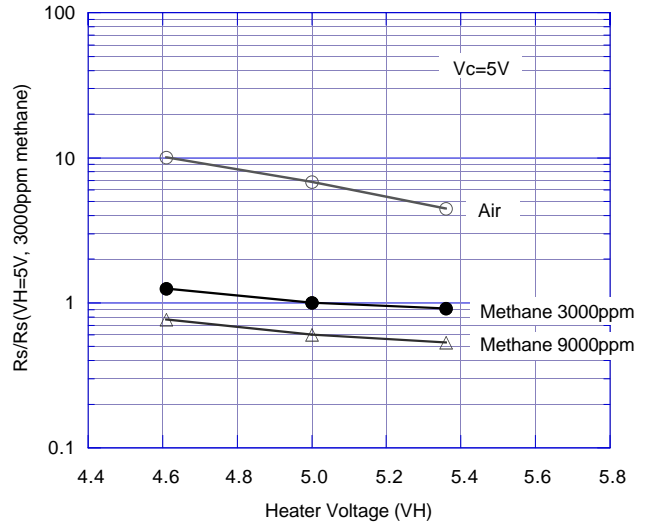

Fig. 8 - Heater voltage dependency (Vc=5.0)

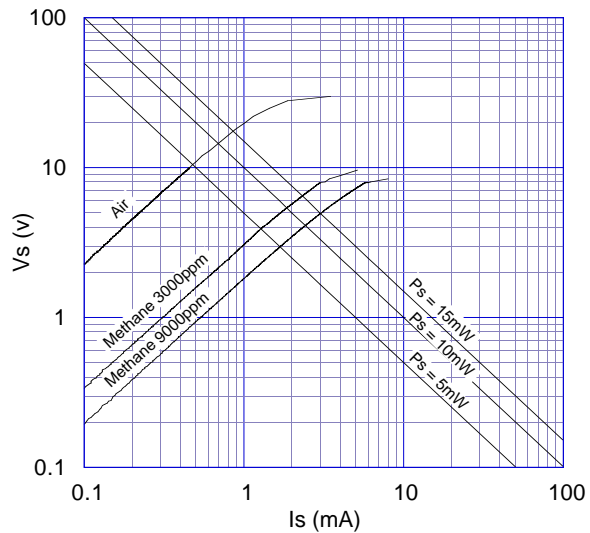

Fig. 9 - V-I characteristics

Vc	Minimum RL (kΩ)
1	0.017
2.5	0.104
5	0.42

Table 2 - Minimum suggested RL values

2-5 Gas response

Figures 10a and 10b show the change pattern of sensor resistance (R_s) for TGS2611 when the sensor is inserted into and later removed from 5000ppm of methane.

As these charts display, the sensor's response speed to the presence of gas is extremely quick, and when removed from gas, the sensor will recover back to its original value in a short period of time. Compared to TGS2611-C00, TGS2611-E00 shows slower response due to the airflow resistance of the sensor's filter layer.

Figure 11 demonstrates the sensor's repeatability by showing multiple exposures to a 5000ppm concentration of methane. Unlike the test done for Fig. 10, here the sensor is located in a single environment which is exchanged periodically. As a result, though the process of gas diffusion reduces sensor response speed, good repeatability can be seen.

2-6 Initial action

Figure 12 shows the initial action of the sensor resistance (R_s) for a sensor which is stored unenergized in normal air for 90 days and later energized in clean air.

The R_s drops sharply for the first seconds after energizing, regardless of the presence of gases, and then reaches a stable level according to the ambient atmosphere. Such behavior during the warm-up process is called "Initial Action".

Since this 'initial action' may cause a detector to alarm unnecessarily during the initial moments after powering on, it is recommended that an initial delay circuit be incorporated into the detector's design (refer to Technical Advisory 'Technical Information on Usage of TGS Sensors for Toxic and Explosive Gas Leak Detectors'). This is especially recommended for intermittent-operating devices such as portable gas detectors.

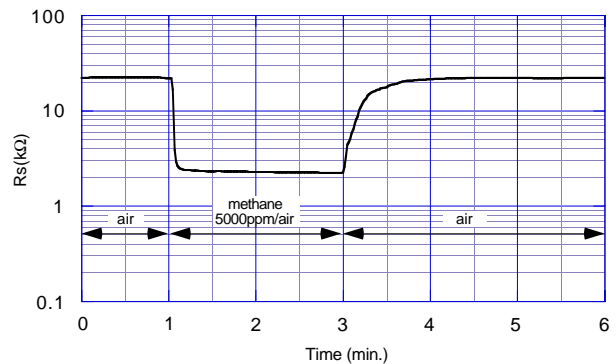

Fig. 10a - Gas response to methane of TGS2611-C00

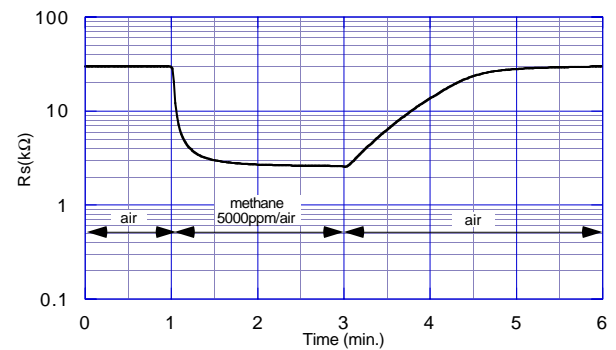

Fig. 10b - Gas response to methane of TGS2611-E00

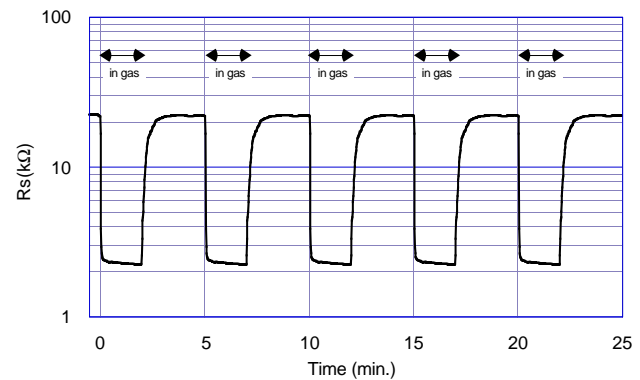

Fig. 11 - Repeatability

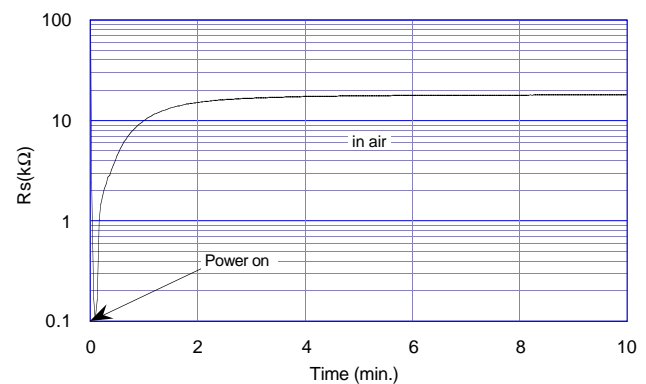

Fig. 12 - Initial action

2-7 Long-term characteristics

Figure 13 shows long-term stability of TGS2611 as measured for more than 500 days. The sensor is usually energized in normal air. Measurement for confirming sensor characteristics is conducted under standard test conditions. The initial value of R_s was measured after preheating for at least three days in normal air at the rated voltage. The Y-axis represents the sensor resistance in air, 3000ppm of methane, 3000ppm of hydrogen, 1000ppm of iso-butane, and 3000ppm of ethanol.

The R_s in methane is very stable over the test period.

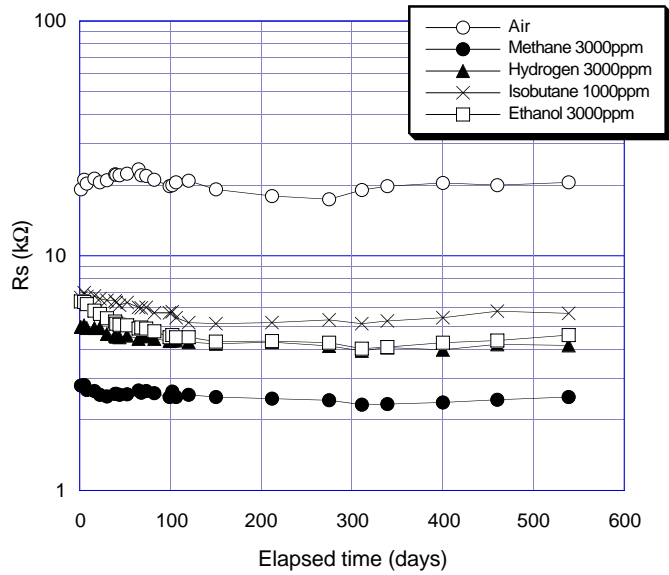

Fig. 13 - Long-term stability (continuous energizing) of TGS2611-C00

Figure 14 shows the influence of storage in an unenergized condition on the sensor's resistance. The sensors were stored unenergized in air for 3 months. During this period, sensors were powered for 1 hour before measurements in the listed gases were taken. At the conclusion of the unenergized test, the sensors were powered under standard test conditions.

The Y-axis represents the sensor resistance in air, 3000ppm of methane, hydrogen, ethanol and 1000ppm of iso-butane.

This chart demonstrates that after long-term unenergized storage, sensor resistance would recover to a stable level within three days of energizing.

As the charts presented in this section illustrate, the sensor shows stable long term characteristics.

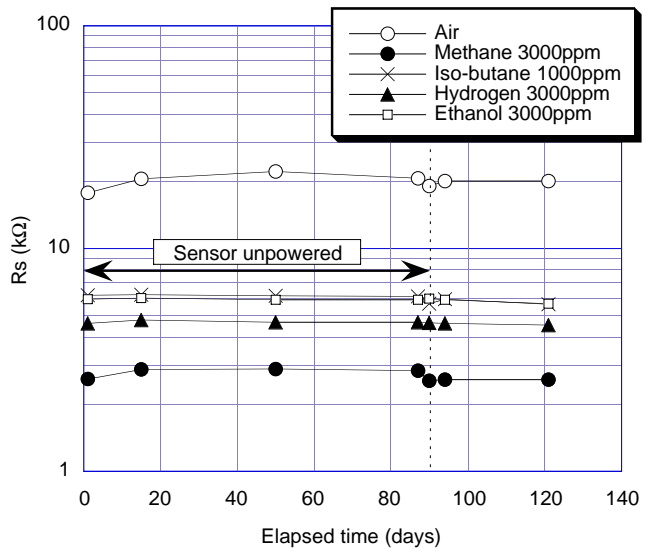

Fig. 14 - Influence of unenergizing on TGS2611-C00

3. Reliability

3-1 Corrosion test

Figure 15 shows the effect on TGS2611 of corrosive gases specified in Item 43.15 of the UL 1484 standard.

Sensor resistance prior to corrosive gas exposure was measured. Unenergized sensors were then placed into an environment of $23^{\circ}\pm 2^{\circ}\text{C}$ and 95%RH. In this environment, two separate tests were conducted: one in 0.1% H₂S, the other in a combination of 0.5% SO₂ and 1.0% CO₂, with each test exposure lasting 10 days. After this exposure, the sensor was re-energized in normal air prior to measuring sensor resistance after removal from corrosive gases.

As this data would suggest, sensor characteristics are temporarily influenced by exposure to corrosive gas concentrations specified by Sec. 43.15 of UL 1484, although the sensor quickly recovers to its normal value after its return to clean air.

3-2 Ignition test

TGS2611 has been successfully tested against the ignition test requirements of the UL1484 standard. The sensor did not initiate ignition of a propane concentration of 5.25% by volume.

3-3 Effect of air flow

Figure 16 shows how the sensor signal (VRL) is affected by air flow. The test procedure involves situating the sensor in an air stream of 3.1 meters per second, with the air flow vertical/horizontal to the flameproof stainless steel double gauze of the sensor's housing.

The decrease in sensor signal shown in Figure 16 resulted from the decrease in sensor element temperature caused by the air flow. As a result, direct air flow on the sensor should be avoided.

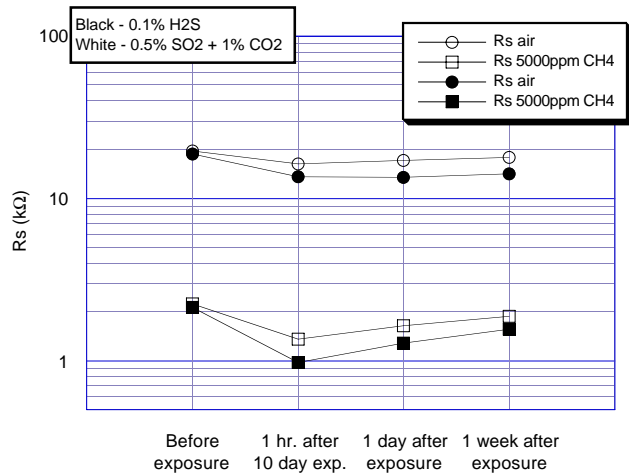

Fig. 15 - Corrosion test of TGS2611-C00

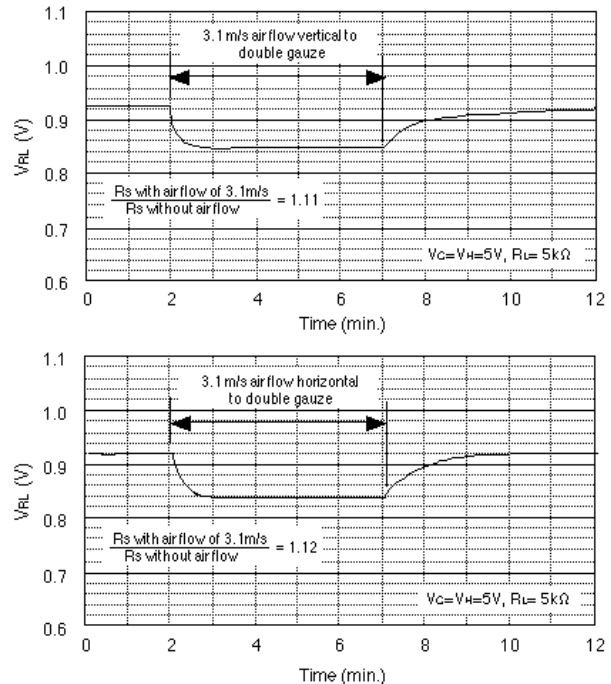

Fig. 16 - Effect of air flow on TGS2611-C00

3-4 Heater resistance durability

Figure 17 illustrates the procedure for testing the effects of excess voltage applied to the heater. Heater resistance was measured while the heater was unpowered and at room temperature.

The results of this test are shown in Figure 18 which shows the change in resistance of the heater when various heater voltages (rather than the standard 5.0V) are applied in the absence of gases.

As this section demonstrates, the heater shows good durability against increased heater voltage. However, since excessive heater voltage will cause the sensor's heater resistance to drift upwards, excessive heater voltage should still be avoided.

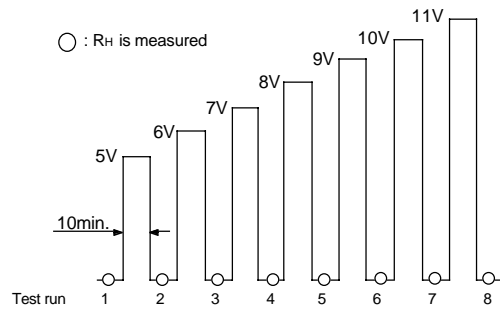

Fig. 17 - Test procedure for heater durability

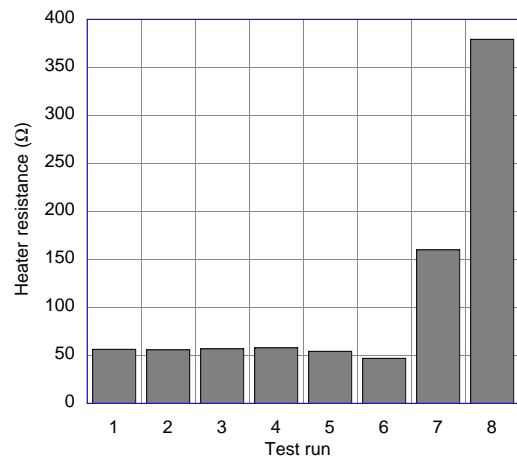

Fig. 18 - Short-term effect of V_H on R_H

3-5 HMDS test

Figure 19a shows the effect on TGS2611-C00 of silicone vapor as specified in Item 5.3.13 of the ES (European standard) EN50194.

Sensor resistance prior to HMDS (Hexamethyl disiloxane) gas exposure was measured (R_0). Energized sensors were placed into an environment of 20°C, 50%RH. In this environment, the sensors were exposed 10 ppm of HMDS for 40 minutes. After exposure, the sensor was returned to normal air. Sensor resistance (R_s) in both air and 5000 ppm of methane were measured at 1 hour, 1 day, and 1 week after being removed from HMDS.

As this data would suggest, sensor characteristics remain largely unaffected by exposure to HMDS gas concentrations specified by Item 5.3.13 of ES EN50194.

However, silicone vapor (which is of low molecular weight) can easily be thermally decomposed to silicone dioxide (SiO_2) by the working temperature of the sensor. Decomposed SiO_2 would cause deactivation of the catalyst in the sensing material and therefore decrease the sensor's resistance in air and alter its sensitivity to gas (see Fig. 19b).

Figures 19b and 19c show durability test data for HMDS concentrations higher than those used in Fig. 19a. The effectiveness of the filter inside the cap of TGS2611-E00 at reducing the effects of HMDS can be seen when comparing the extent of changes in $R_s(\text{air})$ between TGS2611-E00 (Fig. 20c) and TGS2611-C00 (Fig. 20b).

3.6 Lighter gas exposure test

Consumers often check if detectors are actually sensing gas by exposing them to lighter gas (main component is iso-butane). Because the filter will block iso-butane from reaching the sensing element, this test **cannot** be used with TGS2611-E00.

Although testing with methane gas is preferable, lighter gas may be used, although special care must be used when doing so. If testing is conducted properly, the estimated gas exposure is less than 10% and would cause no lasting harmful effects to the sensor. Improper testing may expose the sensor to more than 10% iso-butane and potentially harm the sensor.

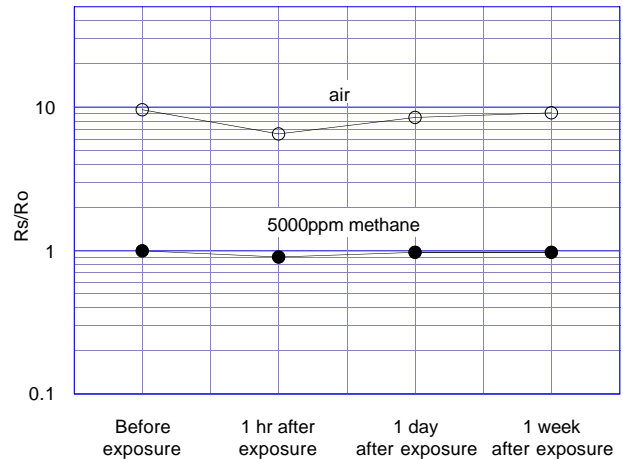

Fig. 19a - Durability to HMDS exposure for TGS2611-C00 ($R_0 = R_s$ in 5000ppm methane before exposure)

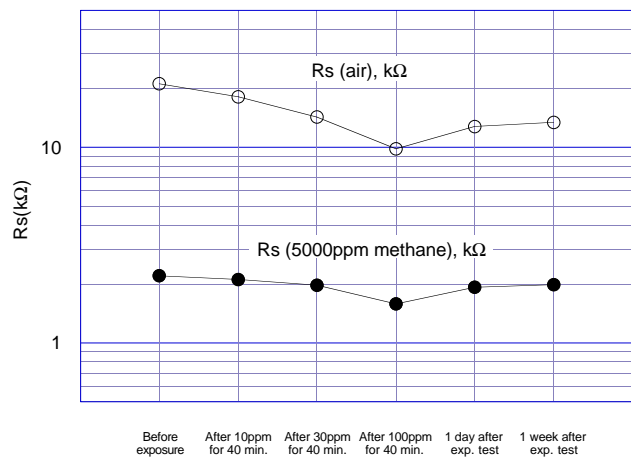

Fig. 19b - Durability to HMDS exposure for TGS2611-C00

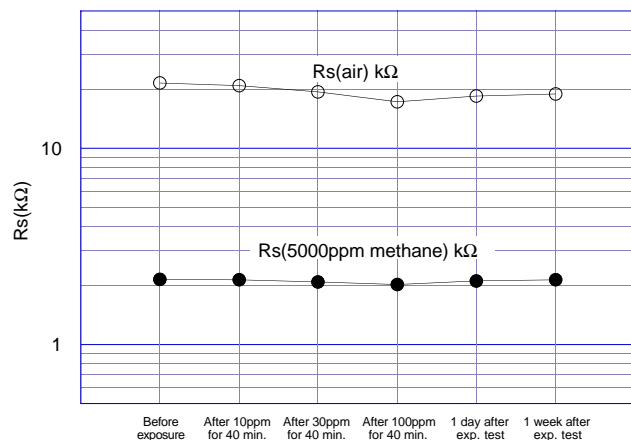

Fig. 19c - Durability to HMDS exposure for TGS2611-E00

To simulate the conditions of an improperly conducted lighter gas test, an energized sensor was exposed to 10% iso-butane for 60 seconds under standard circuit conditions. After returning the sensor to normal air, the R_s in air, 3000, 5000, and 9000 ppm of methane was measured at the intervals after exposure as shown in Figure 20.

The result of the above test is shown in Fig. 20. A 10% iso-butane exposure for 60 seconds appears to cause an increase in R_s in gas. Furthermore, sensor resistance would take more than one week to recover to its original value after energizing in normal air.

Prolonged exposure to in excess of 10% iso-butane may cause a permanent change in the sensor's characteristics due to combustion of gas on the surface of the sensing material and/or heater. Therefore, Figaro cautions that, if a lighter gas test is done, it must be carefully administered to avoid sensor damage.

NOTE: To achieve the optimal level of accuracy in gas detectors, each TGS2611 sensor should be individually calibrated by matching it with a load resistor (R_L) in an environment containing the target gas concentration for alarming (refer to Fig. 2).

For the convenience of users, TGS2611 is classified into 24 groups according to the each sensor's R_s in methane. ID numbers marked on the sensor's body indicate the sensor's grouping. Individual sensor calibration can be eliminated by matching the sensor with the recommended R_L for each sensor ID. However, because group calibration is used instead of individual calibration, an average of 10% less accuracy would result for detectors using group calibration. Please refer to "Application Notes for TGS2611" for more information.

4 Cautions on Usage of Figaro Gas Sensors

4-1 Situations which must be avoided

1) Exposure to silicone vapors

If silicone vapors adsorb onto the sensor's surface, the sensing material will be coated, irreversibly inhibiting sensitivity. Avoid exposure where silicone adhesives, hair grooming materials, or silicone rubber/putty may be present.

2) Highly corrosive environment

High density exposure to corrosive materials such

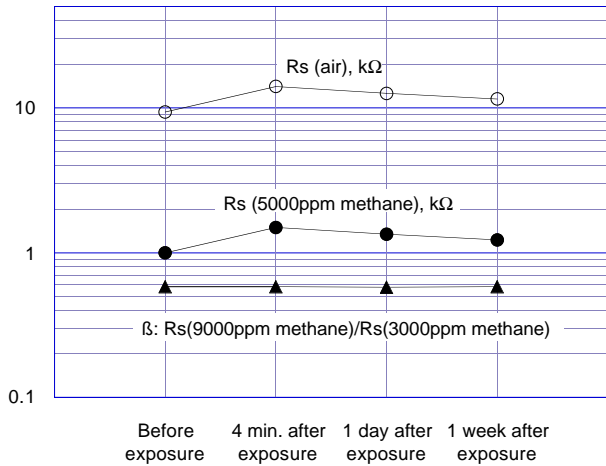

Fig. 20 - Lighter gas exposure test of TGS2611-C00

as H_2S , SO_x , Cl_2 , HCl , etc. for extended periods may cause corrosion or breakage of the lead wires or heater material.

3) Contamination by alkaline metals

Sensor drift may occur when the sensor is contaminated by alkaline metals, especially salt water spray.

4) Contact with water

Sensor drift may occur due to soaking or splashing the sensor with water.

5) Freezing

If water freezes on the sensing surface, the sensing material would crack, altering characteristics.

6) Application of excessive voltage

If higher than specified voltage is applied to the sensor or the heater, lead wires and/or the heater may be damaged or sensor characteristics may drift, even if no physical damage or breakage occurs.

7) Operation in zero/low oxygen environment

TGS sensors require the presence of around 21% (ambient) oxygen in their operating environment in order to function properly and to exhibit characteristics described in Figaro's product literature. TGS sensors cannot properly operate in a zero or low oxygen content atmosphere.

8) Excessive exposure to alcohol

IF TGS2611-E00 is exposed to high concentrations of alcohol (such as 10,000ppm or more) for a long period of time, the filter may become saturated. In this case,

the sensor would show a lower resistance in alcohol than that indicated in Figure 4a.

4-2 Situations to be avoided whenever possible

1) Water condensation

Light condensation under conditions of indoor usage should not pose a problem for sensor performance. However, if water condenses on the sensor's surface and remains for an extended period, sensor characteristics may drift.

2) Usage in high density of gas

Sensor performance may be affected if exposed to a high density of gas for a long period of time, regardless of the powering condition.

3) Storage for extended periods

When stored without powering for a long period, the sensor may show a reversible drift in resistance according to the environment in which it was stored. The sensor should be stored in a sealed bag containing clean air; do not use silica gel. *Note that as unpowered storage becomes longer, a longer preheating period is required to stabilize the sensor before usage.*

4) Long term exposure in adverse environment

Regardless of powering condition, if the sensor is exposed in extreme conditions such as very high

humidity, extreme temperatures, or high contamination levels for a long period of time, sensor performance will be adversely affected.

5) Vibration

Excessive vibration may cause the sensor or lead wires to resonate and break. Usage of compressed air drivers/ ultrasonic welders on assembly lines may generate such vibration, so please check this matter.

6) Shock

Breakage of lead wires may occur if the sensor is subjected to a strong shock.

7) Soldering

Ideally, sensors should be soldered manually. However, wave soldering can be done under the following conditions:

a) Suggested flux: rosin flux with minimal chlorine

b) Speed: 1-2 meters/min.

c) Preheating temperature: 100±20°C

d) Solder temperature: 250±10°C

e) Up to two passes through wave soldering machine allowed

Results of wave soldering cannot be guaranteed if conducted outside the above guidelines since some flux vapors may cause drift in sensor performance similar to the effects of silicone vapors.

Figaro USA Inc. and the manufacturer, Figaro Engineering Inc. (together referred to as Figaro) reserve the right to make changes without notice to any products herein to improve reliability, functioning or design. Information contained in this document is believed to be reliable. However, Figaro does not assume any liability arising out of the application or use of any product or circuit described

herein; neither does it convey any license under its patent rights, nor the rights of others.

Figaro's products are not authorized for use as critical components in life support applications wherein a failure or malfunction of the products may result in injury or threat to life.

FIGARO GROUP

HEAD OFFICE

Figaro Engineering Inc.
1-5-11 Senba-nishi
Mino, Osaka 562-8505 JAPAN
Tel.: (81) 72-728-2561
Fax: (81) 72-728-0467
email: figaro@figaro.co.jp

OVERSEAS

Figaro USA Inc.
3703 West Lake Ave. Suite 203
Glenview, IL 60026 USA
Tel.: (1) 847-832-1701
Fax.: (1) 847-832-1705
email: figarousa@figarosensor.com