

Technical Information for Volatile Organic Compound (VOC) Sensors

The Figaro 2600 series is a new type thick film metal oxide semiconductor, screen printed gas sensor which offers miniaturization and lower power consumption. The TGS2620 displays high selectivity and sensitivity to volatile organic vapors such as ethanol, methanol, etc.

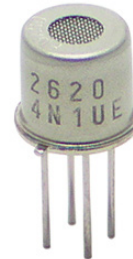

	<u>Page</u>
<i>Basic Information and Specifications</i>	
Features.....	2
Applications.....	2
Structure.....	2
Basic measuring circuit.....	2
Circuit & operating conditions.....	3
Specifications.....	3
Dimensions.....	3
<i>Typical Sensitivity Characteristics</i>	
Sensitivity to various gases.....	4
Temperature and humidity dependency.....	5
Heater & circuit voltage dependency.....	6
Gas response.....	7
Initial action.....	7
Long term characteristics.....	8
<i>Practical Considerations for Circuit Design</i>	
Sensitivity to various organic compounds.....	9
Inrush current of heater.....	9
Effect of air flow.....	10
Heater resistance durability.....	10
<i>Cautions</i>	11

See also Technical Brochure 'Technical Information on Usage of TGS Sensors for Toxic and Explosive Gas Leak Detectors'.

IMPORTANT NOTE: OPERATING CONDITIONS IN WHICH FIGARO SENSORS ARE USED WILL VARY WITH EACH CUSTOMER'S SPECIFIC APPLICATIONS. FIGARO STRONGLY RECOMMENDS CONSULTING OUR TECHNICAL STAFF BEFORE DEPLOYING FIGARO SENSORS IN YOUR APPLICATION AND, IN PARTICULAR, WHEN CUSTOMER'S TARGET GASES ARE NOT LISTED HEREIN. FIGARO CANNOT ASSUME ANY RESPONSIBILITY FOR ANY USE OF ITS SENSORS IN A PRODUCT OR APPLICATION FOR WHICH SENSOR HAS NOT BEEN SPECIFICALLY TESTED BY FIGARO.

1. Basic Information and Specifications

1-1 Features

- * High selectivity to volatile organic vapors
- * Low power consumption
- * Small size
- * Long life

1-2 Applications

- * Alcohol testers
- * Organic vapor detectors/alarms
- * Solvent detectors for factories, dry cleaners, and semiconductor industries

1-3 Structure

Figure 1 shows the structure of TGS2620. Using thick film techniques, the sensor material is printed on electrodes (noble metal) which have been printed onto an alumina substrate. One electrode is connected to pin No.2 and the other is connected to pin No.3. The sensor element is heated by RuO₂ material printed onto the reverse side of the substrate and connected to pins No.1 and No.4.

Lead wires are Pt-W alloy and are connected to sensor pins which are made of Ni-plated Ni-Fe 50%.

The sensor base is made of Ni-plated steel. The sensor cap is made of stainless steel. The upper opening in the cap is covered with a double layer of 100 mesh stainless steel gauze (SUS316).

1-4 Basic measuring circuit

Figure 2 shows the basic measuring circuit. Circuit voltage (V_c) is applied across the sensor element which has a resistance (R_s) between the sensor's two electrodes and the load resistor (R_L) connected in series. When DC is used for V_c, the polarity shown in Figure 2 **must** be maintained. The V_c may be applied intermittently. The sensor signal (V_{RL}) is measured indirectly as a change in voltage across the R_L. The R_s is obtained from the formula shown at the right.

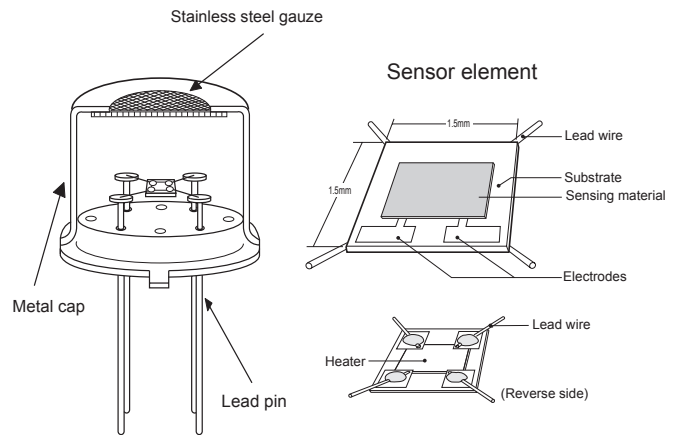

Fig. 1 - Sensor structure

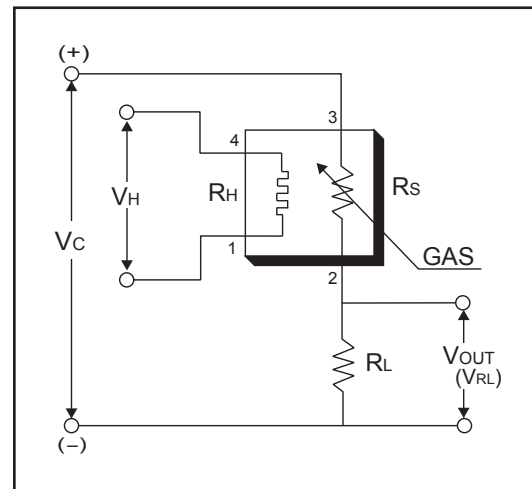

Fig. 2 - Basic measuring circuit

NOTE: In the case of V_H, there is no polarity, so pins 1 and 4 can be considered interchangeable. However, in the case of V_c, when used with DC power, pins 2 and 3 must be used as shown in the Figure above.

$$R_s = \frac{V_c - V_{RL}}{V_{RL}} \times R_L$$

Formula to determine R_s

1-5 Circuit & operating conditions

The ratings shown below should be maintained at all times to insure stable sensor performance:

Item	Specification
Circuit voltage (V _c)	5.0V ± 0.2V AC/DC
Heater voltage (V _H)	5.0V ± 0.2V AC/DC
Heater resistance (room temp)	83Ω (typical)
Load resistance (R _L)	variable (0.45kΩ min.)
Sensor power dissipation (P _s)	≤15mW
Operating & storage temperature	-40°C ~ +70°C
Optimal detection concentration	50 ~ 5,000ppm

1-6 Specifications ^{NOTE1}

Item	Specification
Sensor resistance (300ppm ethanol)	1kΩ ~ 5kΩ
Sensor resistance ratio (β)	0.3 ~ 0.5
$\beta = R_s(300\text{ppm ethanol})/R_s(50\text{ppm ethanol})$	
Heater current (R _H)	42 ± 4mA
Heater power consumption (P _H)	approx. 210mW

NOTE 1: Sensitivity characteristics are obtained under the following standard test conditions:

(Standard test conditions)

Temperature and humidity: 20 ± 2°C, 65 ± 5% RH

Circuit conditions: V_c = 5.0±0.01V DC

V_H = 5.0±0.05V DC

R_L = 10.0kΩ ± 1%

Preheating period: 7 days or more under standard circuit conditions

All sensor characteristics shown in this brochure represent typical characteristics. Actual characteristics vary from sensor to sensor and from production lot to production lot. The only characteristics warranted are those shown in the Specification table above.

1-7 Dimensions

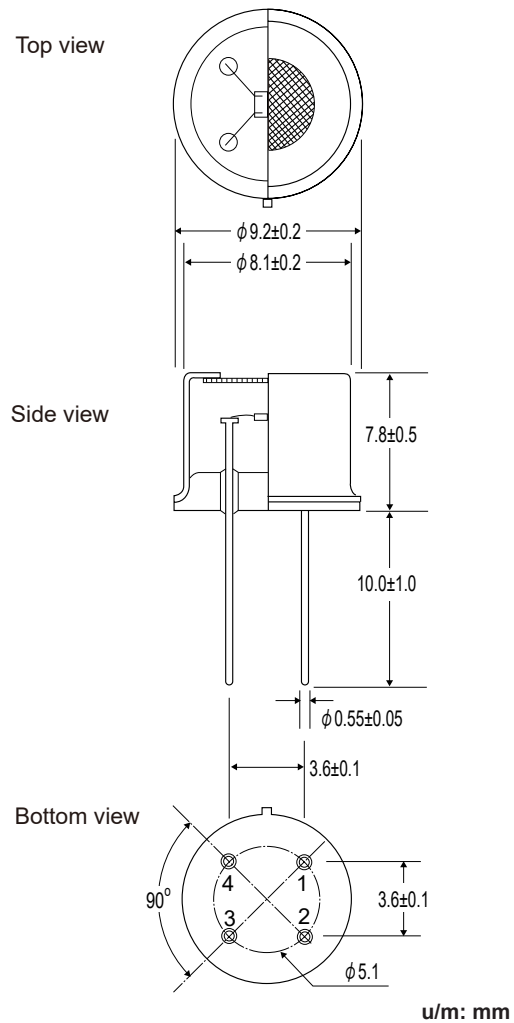

- Pin connection:**
- 1: Heater
 - 2: Sensor electrode (-)
 - 3: Sensor electrode (+)
 - 4: Heater

Fig. 3 - Sensor dimensions

Mechanical Strength:

The sensor shall have no abnormal findings in its structure and shall satisfy the above electrical specifications after the following performance tests:

Withdrawal Force - withstand force of 5kg in each (pin from base) direction

Vibration - frequency-1000c/min., total amplitude-4mm, duration-one hour, direction-vertical

Shock - acceleration-100G, repeated 5 times

2. Typical Sensitivity Characteristics

2-1 Sensitivity to various gases

Figure 4 shows the relative sensitivity of TGS2620 to various gases. The Y-axis shows the ratio of the sensor resistance in various gases (R_s) to the sensor resistance in 300ppm of ethanol (R_o).

Using the basic measuring circuit illustrated in Fig. 2 and with a matched RL value equivalent to the R_s value in 300ppm of ethanol, will provide the sensor output voltage (VRL) change as shown in Figure 5.

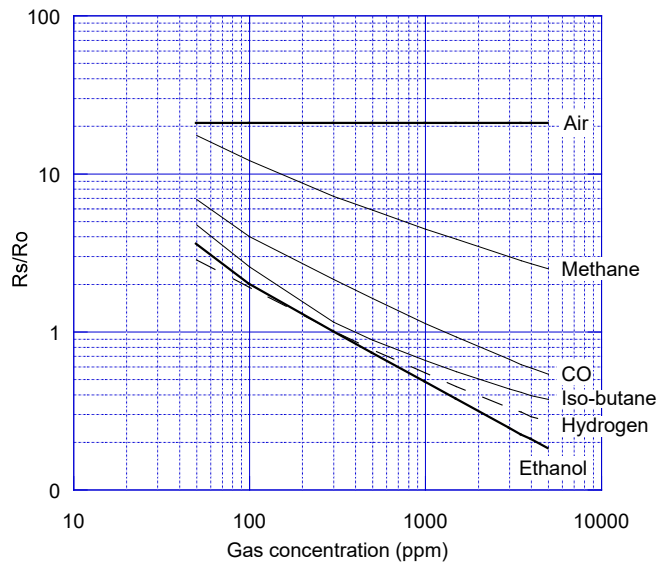

Fig. 4 - Sensitivity to various gases (R_s/R_o)

NOTE:

All sensor characteristics in this technical brochure represent typical sensor characteristics. Since the R_s or output voltage curve varies from sensor to sensor, calibration is required for each sensor (for additional information on calibration, please refer to the Technical Advisory 'Technical Information on Usage of TGS Sensors for Toxic and Explosive Gas Leak Detectors').

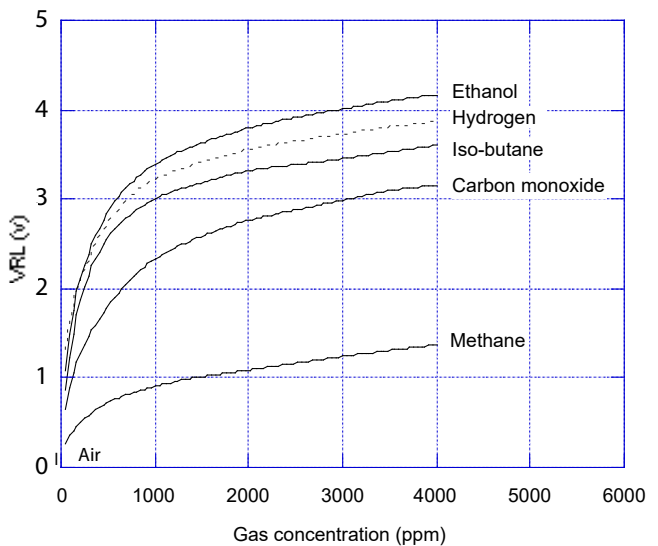

Fig. 5 - Sensitivity to various gases (VRL)

2-2 Temperature and humidity dependency

Figure 6 shows the temperature and humidity dependency of TGS2620. The Y-axis shows the ratio of sensor resistance in 300ppm of ethanol under various atmospheric conditions (R_s) to the sensor resistance in 300ppm of ethanol at 20°C/65%RH (R_o).

RH (°C)	35%RH	50%RH	65%RH	95%RH
-10				1.80
0			1.72	1.35
10		1.48	1.30	0.96
20	1.37	1.20	1.00	0.75
30	1.04	0.88	0.74	0.63
40	0.85	0.73	0.62	0.57

Table 1 - Temperature and humidity dependency (typical values of R_s/R_o for Fig. 6)

Table 1 shows a table of values of the sensor's resistance ratio (R_s/R_o) under the same conditions as those used to generate Figure 6.

Figure 7 shows the sensitivity curve for TGS2620 to ethanol under several ambient conditions. While temperature may have a large influence on absolute R_s values, this chart illustrates the fact that the effect on the slope of the sensor resistance ratio (R_s/R_o) is not significant. As a result, the effects of temperature on the sensor can easily be compensated.

For economical circuit design, a thermistor can be incorporated to compensate for temperature (for additional information on temperature compensation in circuit designs, please refer to the Technical Advisory 'Technical Information on Usage of TGS Sensors for Toxic and Explosive Gas Leak Detectors').

2-3 Heater voltage dependency

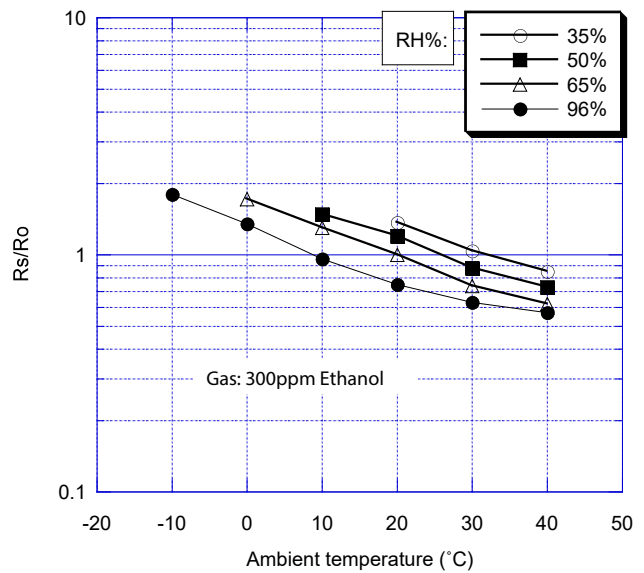

Fig. 6 - Temperature and humidity dependency (R_s/R_o)

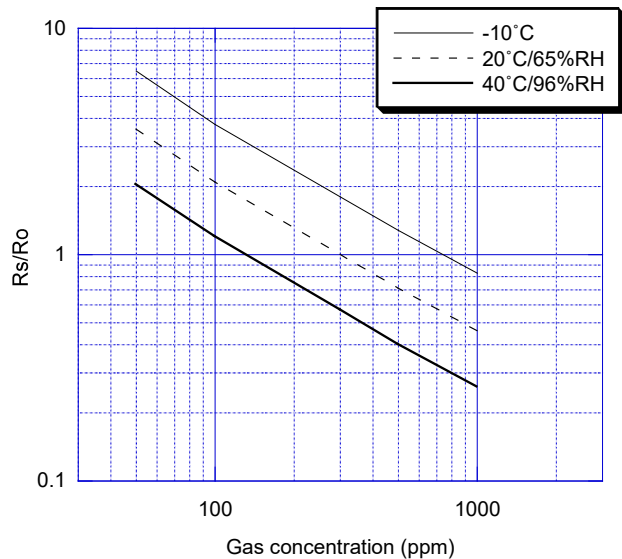

Fig. 7 - Resistance change ratio under various ambient conditions

Figure 8 shows the change in the sensor resistance ratio according to variations in the heater voltage (V_H).

Note that 5.0V as a heater voltage must be maintained because variance in applied heater voltage will cause the sensor's characteristics to be changed from the typical characteristics shown in this brochure.

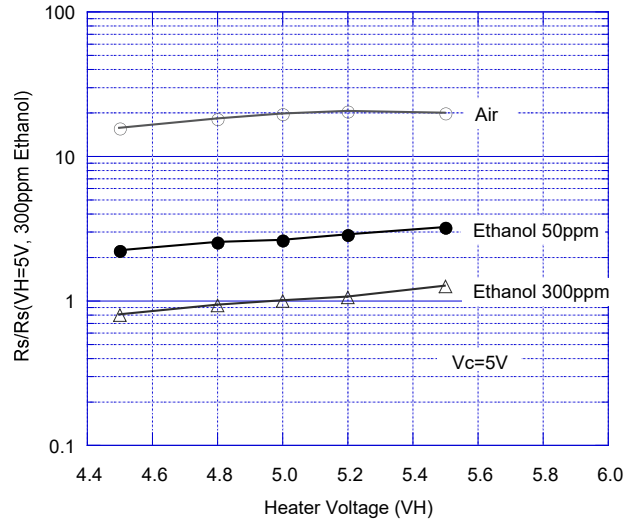

Fig. 8 - Heater voltage dependency (Vc=5.0)

2-4 Circuit voltage dependency

Figure 9 shows the change in the sensor resistance ratio resulting from variation in circuit voltage (V_c).

As shown here, using a V_c higher than the 5.0V specified in Section 1-5 may result in the sensor diverging from Ohmic behavior and thus altering its characteristics from those shown as typical in this brochure.

2-5 Gas response

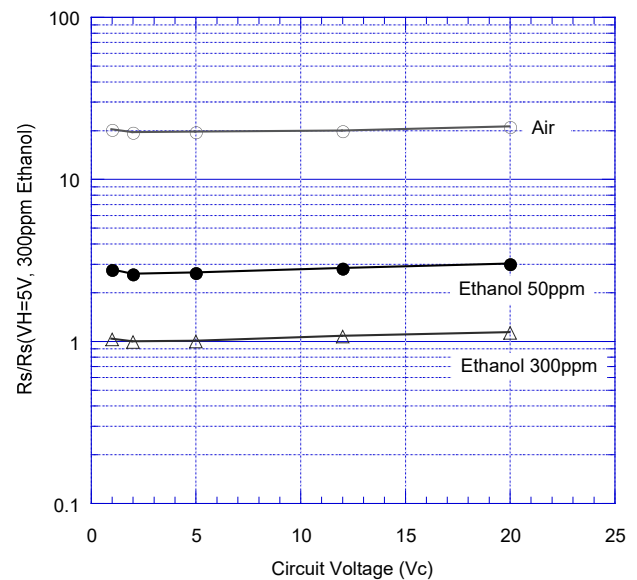

Fig. 9 - Circuit voltage dependency (V_H=5.0)

Figure 10 shows the change pattern of sensor resistance (R_s) when the sensor is inserted into and later removed from 300ppm of ethanol.

As this chart displays, the sensor's response speed to the presence of gas is extremely quick, and when removed from gas, the sensor will recover back to its original value in a short period of time.

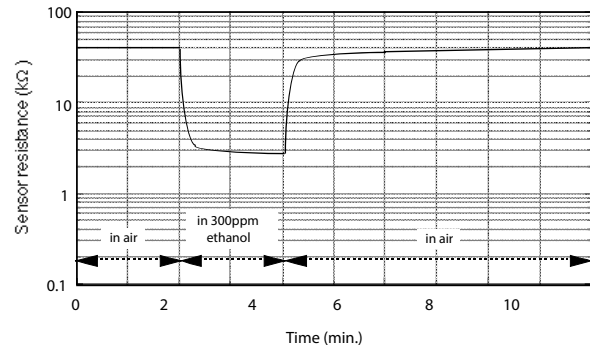

Fig. 10 - Gas response to ethanol

Figure 11 demonstrates the sensor's repeatability by showing multiple exposures to a 300ppm concentration of ethanol. Unlike the test done for Fig. 10, here the sensor is located in a single environment which is exchanged periodically. As a result, though the process of gas diffusion reduces sensor response speed, good repeatability can be seen.

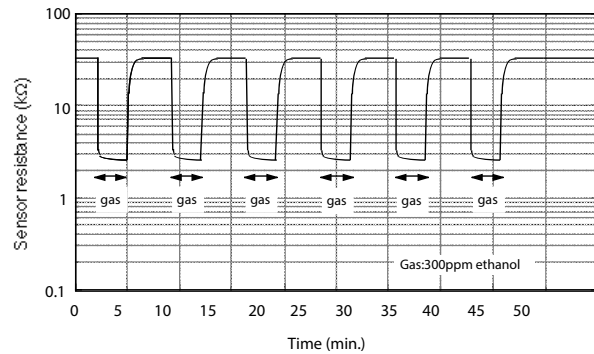

Fig. 11 - Repeatability

2-6 Initial action

Figure 12 shows the initial action of the sensor resistance (R_s) for a sensor which is stored unenergized in normal air for 30 days and later energized in clean air.

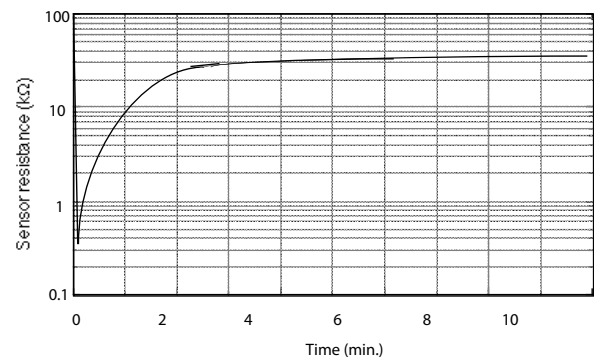

Fig. 12 - Initial action

The R_s drops sharply for the first seconds after energizing, regardless of the presence of gases, and then reaches a stable level according to the ambient atmosphere. Such behavior during the warm-up process is called "Initial Action".

Since this 'initial action' may cause a detector to alarm unnecessarily during the initial moments after powering on, it is recommended that an initial delay circuit be incorporated into the detector's design (refer to Technical Advisory 'Technical Information on Usage of TGS Sensors for Toxic and Explosive Gas Leak Detectors'). This is especially recommended for intermittent-operating devices such as portable gas detectors.

2-7 Long-term characteristics

Figure 13 shows long-term stability of TGS2620 as measured for more than 700 days. The sensor is first energized in normal air. Measurement for confirming sensor characteristics is conducted under standard test conditions. The initial value of R_s was measured after two days energizing in normal air at the rated voltage. The Y-axis represents the sensor resistance in air, 1000ppm of hydrogen, 100ppm of carbon monoxide, and 300ppm of ethanol.

The R_s in both ethanol and hydrogen is very stable over the test period.

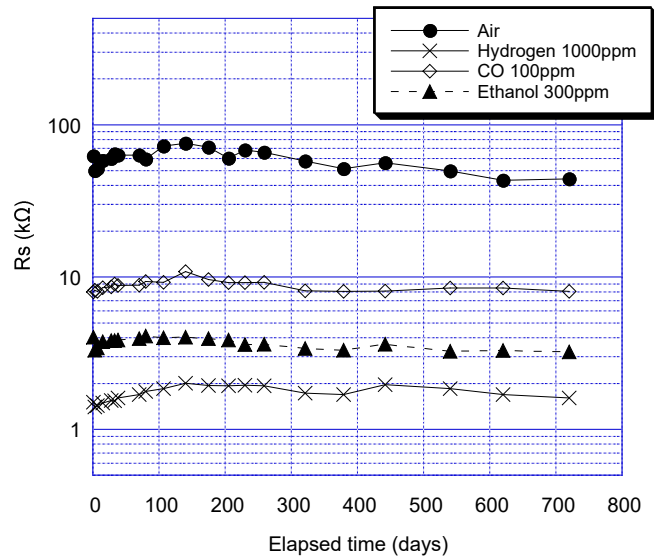

Fig. 13 - Long-term stability (continuous energizing)

Figure 14 shows the influence of storage in an unenergized condition on the sensor's resistance. The sensors were stored unenergized in air after 20 days energizing, then energized for one hour before a measurement was taken.

As the charts presented in this section illustrate, the sensor shows stable long term characteristics.

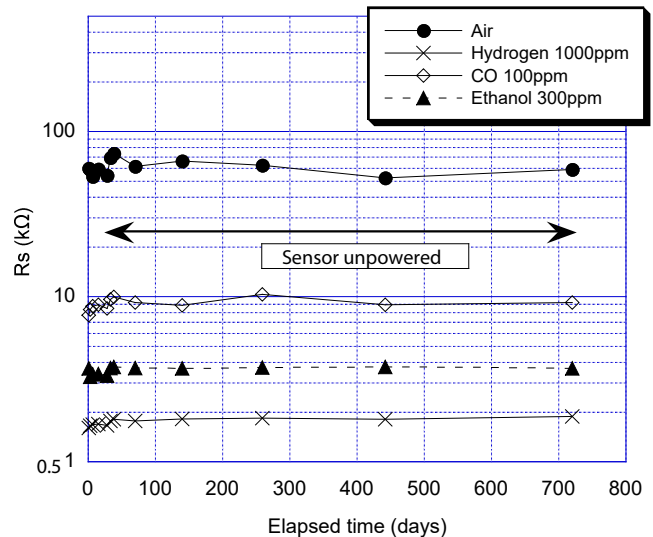

Fig. 14 - Influence of unenergizing

3. Practical Considerations for Circuit Design

3-1 Sensitivity to various organic compounds

Figure 15 shows the sensitivity of TGS2620 to various kinds of gases at concentrations of 100ppm and 1000ppm. The x-axis shows the sensitivity ratio of sensor resistance in clean air (R_{air}) versus sensor resistance in the listed gas (R_{gas}).

This data demonstrates that TGS2620 is an excellent general purpose sensor for VOCs as it shows good sensitivity to many kinds of organic compound vapors. **NOTE:** This data is shown only for demonstrating the high sensitivity of the sensor to VOC's--never use R_{air} as a reference for calibration.

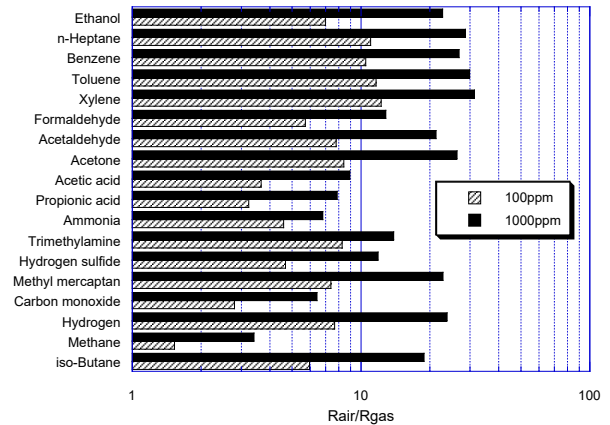

Fig. 15 - Sensitivity to various organic compounds

3-2 Inrush current of heater

The heater material of the sensor has its own temperature dependency. Figure 16 shows both the inrush current and steady state of heater current under various ambient temperatures for the TGS2620. This chart illustrates that inrush current is approximately 40% higher than the steady state current. Since heater resistance shows a lower value at low temperatures, this would cause a larger than expected current at room temperature. As a result, when a device using the sensor is first powered on, an extremely high current may be generated during the first few moments of energizing. Therefore protection from inrush current should be considered for incorporation into circuit design.

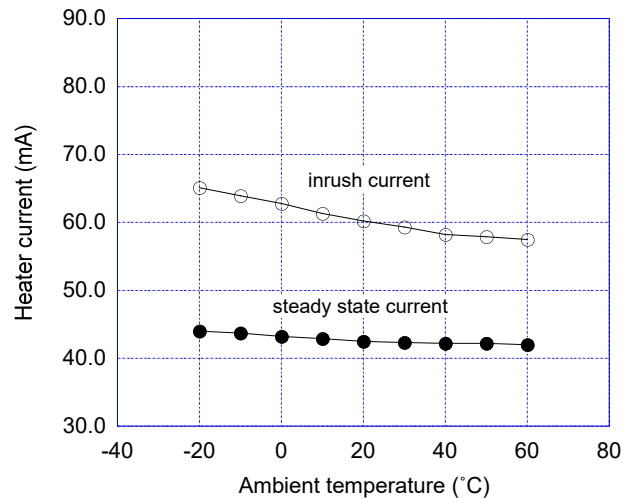

Fig. 16 - Temperature dependency of heater current

In actual application, it should be noted that the period of inrush current would last less than 10 seconds, after which the heater current reaches to a constant value as shown in Figure 17.

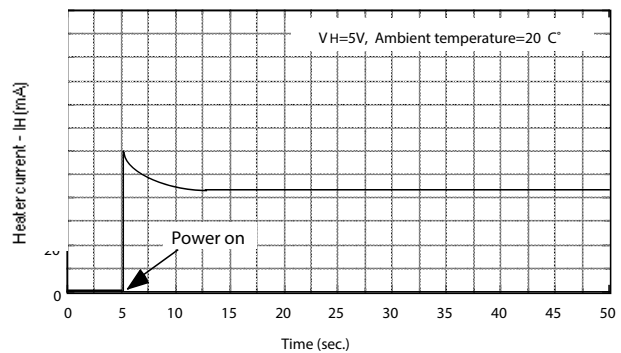

Fig. 17 - Change in heater current after powering on

3-3 Effect of air flow

Figure 18 shows how the sensor signal (V_{RL}) is affected by air flow. The test procedure involves situating the sensor in an air stream of 3.1 meters per second, with the air flow vertical/horizontal to the flameproof stainless steel double gauze of the sensor's housing.

The increase in sensor signal shown in Figure 18 resulted from the decrease in sensor element temperature caused by the air flow. As a result, direct air flow on the sensor should be avoided.

3-4 Heater resistance durability

Figure 19 illustrates the procedure for testing the effects of excess voltage applied to the heater. Heater resistance was measured while the heater was un-powered and at room temperature.

The results of this test are shown in Figure 20 which shows the change in resistance of the heater when various heater voltages (rather than the standard 5.0V) are applied in the absence of gases.

As this section demonstrates, the heater shows good durability against increased heater voltage. However, since excessive heater voltage will cause the sensor's heater resistance to drift upwards, excessive heater voltage should still be avoided.

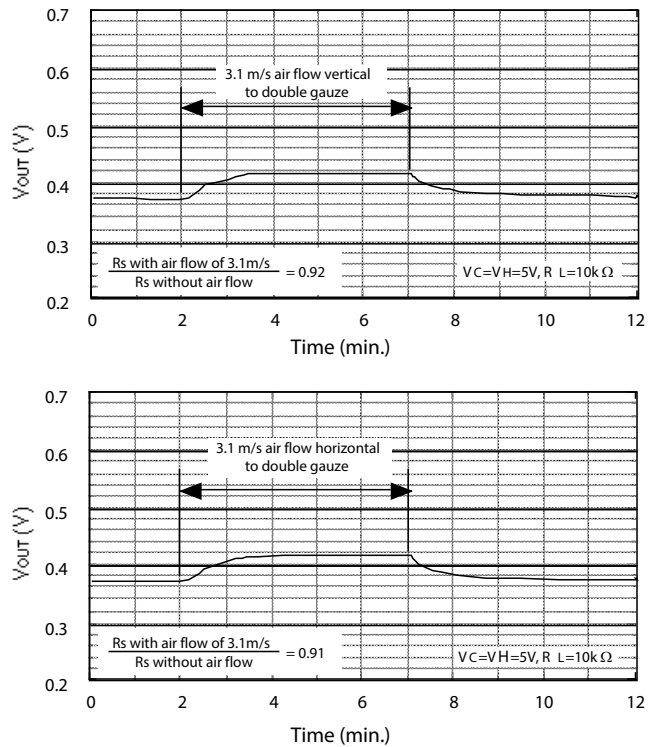

Fig. 18 - Effect of air flow

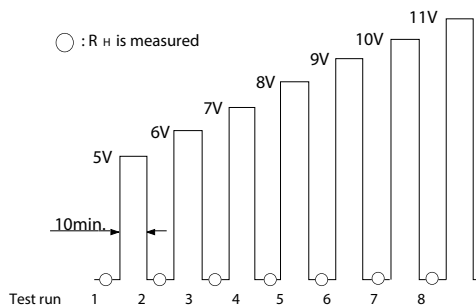

Fig. 19 - Test procedure for heater durability

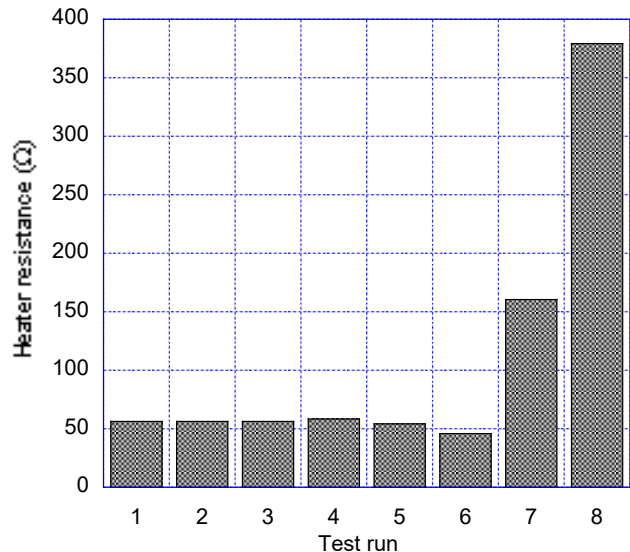

Fig. 20 - Short term effect of V_H on R_H

4. Cautions

4-1 Situations which must be avoided

1) Exposure to silicone vapors

If silicone vapors adsorb onto the sensor's surface, the sensing material will be coated, irreversibly inhibiting sensitivity. Avoid exposure where silicone adhesives, hair grooming materials, or silicone rubber/putty may be present.

2) Highly corrosive environment

High density exposure to corrosive materials such as H₂S, SO_x, Cl₂, HCl, etc. for extended periods may cause corrosion or breakage of the lead wires or heater material.

3) Contamination by alkaline metals

Sensor drift may occur when the sensor is contaminated by alkaline metals, especially salt water spray.

4) Contact with water

Sensor drift may occur due to soaking or splashing the sensor with water.

5) Freezing

If water freezes on the sensing surface, the sensing material would crack, altering characteristics.

6) Application of excessive voltage

If higher than specified voltage is applied to the sensor or the heater, lead wires and/or the heater may be damaged or sensor characteristics may drift, even if no physical damage or breakage occurs.

7) Operation in zero/low oxygen environment

TGS sensors require the presence of around 21% (ambient) oxygen in their operating environment in order to function properly and to exhibit characteristics described in Figaro's product literature. TGS sensors cannot properly operate in a zero or low oxygen content atmosphere.

8) Polarization

These sensors have polarity. Incorrect V_c connection may cause significant deterioration of long term stability. Please connect V_c according to specifications.

4-2 Situations to be avoided whenever possible

1) Water condensation

Light condensation under conditions of indoor usage should not pose a problem for sensor performance.

However, if water condenses on the sensor's surface and remains for an extended period, sensor characteristics may drift.

2) Usage in high density of gas

Sensor performance may be affected if exposed to a high density of gas for a long period of time, regardless of the powering condition.

3) Storage for extended periods

When stored without powering for a long period, the sensor may show a reversible drift in resistance according to the environment in which it was stored. The sensor should be stored in a sealed bag containing clean air; do not use silica gel. *Note that as unpowered storage becomes longer, a longer preheating period is required to stabilize the sensor before usage.*

4) Long term exposure in adverse environment

Regardless of powering condition, if the sensor is exposed in extreme conditions such as very high humidity, extreme temperatures, or high contamination levels for a long period of time, sensor performance will be adversely affected.

5) Vibration

Excessive vibration may cause the sensor or lead wires to resonate and break. Usage of compressed air drivers/ultrasonic welders on assembly lines may generate such vibration, so please check this matter.

6) Shock

Breakage of lead wires may occur if the sensor is subjected to a strong shock.

7) Soldering

Ideally, sensors should be soldered manually. However, wave soldering can be done under the following conditions:

a) Suggested flux: rosin flux with minimal chlorine

b) Speed: 1-2 meters/min.

c) Preheating temperature: 100±20°C

d) Solder temperature: 250±10°C

e) Up to two passes through wave soldering machine allowed

Results of wave soldering cannot be guaranteed if conducted outside the above guidelines since some flux vapors may cause drift in sensor performance similar to the effects of silicone vapors.

Figaro USA Inc. and the manufacturer, Figaro Engineering Inc. (together referred to as Figaro) reserve the right to make changes without notice to any products herein to improve reliability, functioning or design. Information contained in this document is believed to be reliable. However, Figaro does not assume any liability arising out of the application or use of any product or circuit described herein; neither does it convey any license under its patent rights, nor the rights of others.

Figaro's products are not authorized for use as critical components in life support applications wherein a failure or malfunction of the products may result in injury or threat to life.

Before purchasing this product, please read the Warranty Statements shown in our webpage by scanning this QR code.



https://www.figaro.co.jp/en/pdf/Limited_Warranty_en.pdf

FIGARO ENGINEERING INC.

1-5-11 Senba-nishi
Mino, Osaka 562-8505 JAPAN
Phone: (81)-727-28-2045
email: figaro@figaro.co.jp
www.figaro.co.jp