

**FIGARO**

*an ISO9001 company*

**Technical Information for Figaro Oxygen Sensor SK-25F**

The Figaro Oxygen Sensor SK-25F is a unique galvanic cell type oxygen sensor which provides a linear output voltage signal relative to percent oxygen present in a particular atmosphere. The sensor features no position dependency, excellent chemical durability, and it is not influenced by CO<sub>2</sub>, making it ideal for oxygen monitoring.



	<u>Page</u>
<i>Introduction</i> .....	2
<i>Basic Information and Specifications</i>	
Features.....	2
Applications.....	2
Structure and Operating Principle.....	2
Specifications.....	2
Absolute Maximum Operating and Storage Conditions.....	3
Dimensions.....	3
<i>Typical Sensitivity Characteristics</i>	
Sensitivity to Oxygen.....	3
Response Speed.....	4
Influence from Various Gases.....	4
Effects of Pressure Change.....	4
Humidity Dependency.....	5
Temperature Dependency.....	5
<i>Reliability</i>	
Influence of Organic Solvents.....	6
Life Expectancy.....	6
Relationship of Expected Life and O <sub>2</sub> Concentration.....	6
Relationship of Expected Life and Storage Temperature.....	6
Long Term Stability.....	7
<i>Handling Instructions</i> .....	7
<i>Warranty</i> .....	8

## 1. Basic Information and Specifications

### 1-1 Features

- \* Virtually no influence from CO<sub>2</sub>, CO, H<sub>2</sub>S, NO, H<sub>2</sub>
- \* Temperature compensation circuit included
- \* Good linearity
- \* No position dependency
- \* Stable output signal
- \* No external power supply required for sensor operation
- \* No warmup time is required

### 1-2 Applications

- \* Safety - Air conditioners, oxygen detectors, fire detectors, fuel cell systems
- \* Measurement - Oxygen monitors in flue gas
- \* Biotechnology - Oxygen incubators, anaerobic cultivators
- \* Food industry - Refrigeration, greenhouses

### 1-3 Structure and operating principle

The SK-25F is a lead-oxygen battery which incorporates a lead anode, an oxygen cathode made of gold, and a weak acid electrolyte. Oxygen molecules enter the electrochemical cell through a non-porous fluorine resin membrane and are reduced at the gold electrode with the acid electrolyte. The current which flows between the electrodes is proportional to the oxygen concentration in the gas mixture being measured. The terminal voltages across the thermistor (for temperature compensation) and resistor are read as a signal, with the change in output voltages representing the change in oxygen concentration.

The following chemical reactions which take place in SK-25F:

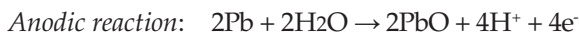
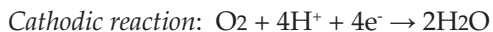

A small volume air bubble is contained inside the sensor body in order to compensate for internal influence from pressure changes. The sensor's electrolyte is primarily composed of acetic acid with a pH of approximately 6. The sensor's body is made of ABS resin.

### 1-4 Specifications

Table 1 shows the specifications of SK-25F.

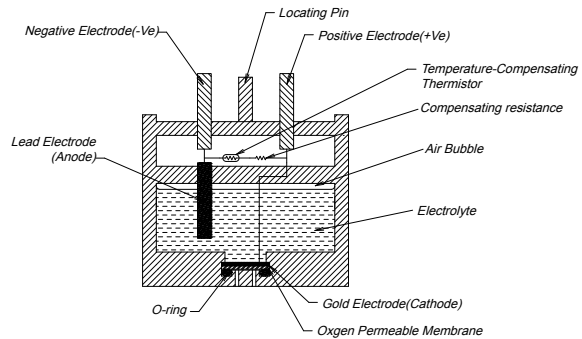

Fig. 1 - Structure of SK-25F

Item		Model
		SK-25F
Measurement range		0~30% O <sub>2</sub>
Accuracy (Note 1)		±1% full scale
Operating conditions	Atmospheric pressure	1013hPa ± 20%
	Temperature	-10°~50°C
	Relative humidity	0~99%RH (no condensation)
Response time (90%) (Note 2)		≤ 15 seconds
Initial output voltage under factory test conditions		5.5~8.5mV
Factory test conditions	Atmospheric pressure	1013hPa
	Temperature	25°±5°C
Life expectancy at 20°C in normal air (Note 3)		approx. 3 years

**Notes:**

- 1) When calibrated at both 0% and 30% of O<sub>2</sub>, accuracy in the range from 0-30% O<sub>2</sub> shall be within ±1% of full scale.
- 2) Sensors should be used under conditions where the air exchange is greater than 200~300ml/minute in order to obtain the response speed as specified in Table 1.
- 3) Life expectancy at 20°C in normal air (1013hPa / 20.7%O<sub>2</sub>) is defined as the period until sensor output drops to 60% of original value.

Table 1 - Specifications of SK-25F

# TECHNICAL INFORMATION FOR SK-25F

## 1-5 Absolute maximum operating and storage conditions

The accumulated total duration of exposure to the absolute maximum conditions listed in Table 2 should be limited to no more than 24 hours.

### Cautions:

- 1) Beneath the lower pressure limit, sensor life may become shorter due to excessive evaporation of the liquid electrolyte.
- 2) At pressure in excess of the upper limit, sensor output may become unstable due to excessive air entering through the o-ring.
- 3) In the range -10~-20°C, the electrolyte will freeze and the sensor will not function, but SK-25F would not be damaged by freezing of the electrolyte and will resume functioning after the electrolyte thaws to a liquid state. Below -20°C, the sensor may be damaged by freezing of the electrolyte, resulting in possible leakage of the electrolyte.
- 4) At temperatures in excess of the upper limit, the sensor life may become shorter than the specification due to evaporation of the electrolyte.
- 5) If used for a long period in an extremely dry environment, sensor life may be shortened due to excessive evaporation of the liquid electrolyte.

Item	Lower limit	Upper limit
Pressure	507hPA (Note 1)	1520hPA (Note 2)
Temperature	-20°C (Note 3)	60°C (Note 4)
Relative humidity	0%RH (Note 5)	100%RH

Table 2 - Absolute maximum operating and storage conditions of SK-25F

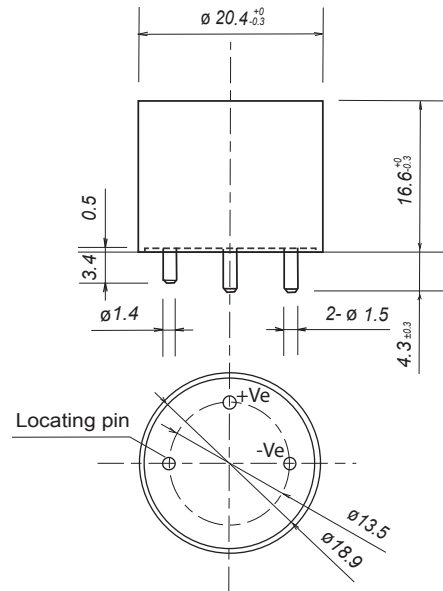

u/m: mm

If not specified, all tolerances are  $\pm 0.2$  mm

Figure 2 - Dimensions of SK-25F

## 1-6 Dimensions (see Fig. 2)

## 2. Typical Sensitivity Characteristics

### 2-1 Sensitivity to oxygen

Figure 3 shows the sensitivity characteristics of SK-25F. The Y-axis indicates the output voltage of the sensor.

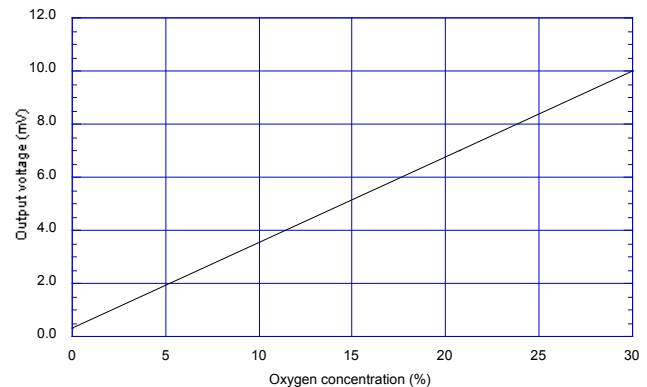

Fig. 3 - SK-25F sensitivity characteristics

## 2-2 Response time

Figure 4 demonstrates the response pattern of the sensor's output voltage. The Y-axis indicates the output voltage ratio(%) to saturated voltage. Typical response time to 90% of saturated response is 12 seconds for SK-25F.

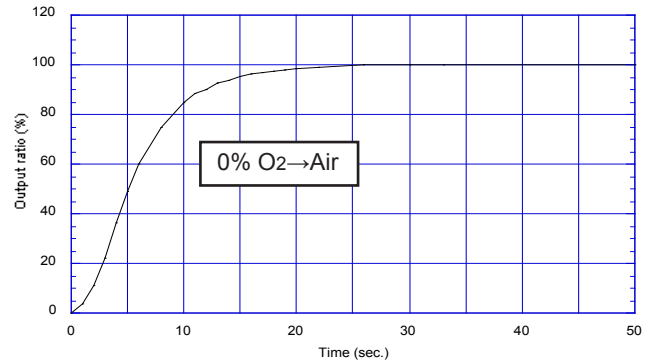

Fig. 4 - Response speed of SK-25F to oxygen

## 2-3 Influence of various gases

The influence on SK-25F from various gases is shown in Table 3. The 'interference level' shown in the table indicates output change converted into oxygen gas concentration(%). For example, if 1% NO<sub>2</sub> gas coexists in air at 20°C/50%RH (20.7% oxygen), sensor output will be about 0.6% larger and the measured oxygen concentration will be 20.7+0.6=21.3%.

Gas	Concentration	Interference Level
Carbon monoxide	400ppm/air	no effect
Carbon dioxide	100%	no effect
Nitric monoxide	1%/N <sub>2</sub>	no effect
Nitrogen dioxide	1%/N <sub>2</sub>	0.6% over output
Sulfur dioxide	1%/N <sub>2</sub>	no effect
Hydrogen sulfide	50ppm/N <sub>2</sub>	no effect
Ammonia	1%/air	no effect

Table 3 - Influence of various gases on SK-25F

## 2-4 Effects of pressure change

The pressure dependency of SK-25F can be seen in Figure 5. In this range of atmospheric pressure, sensor output voltage maintains a linear relationship when compared with atmospheric pressure.

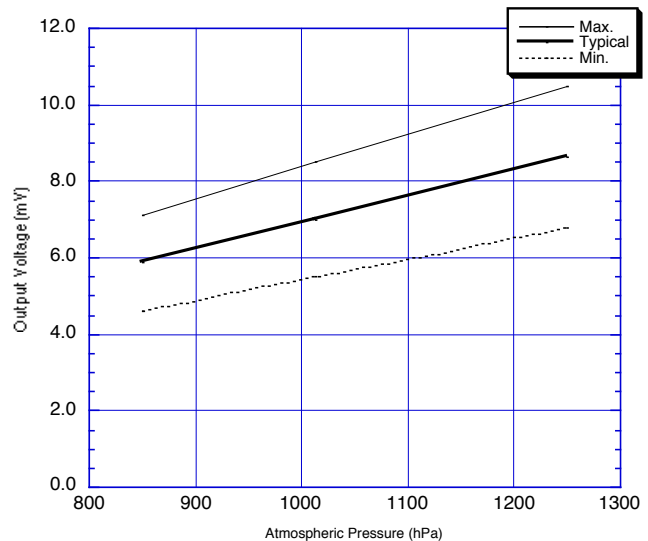

Fig. 5 - SK-25F response of output voltage to ambient pressure changes (at 25°C/60%RH)

2-5 Humidity dependency

Figure 6 displays an example of humidity dependency for SK-25F. The Y-axis shows ratio of sensor output voltage at various relative humidities to sensor output voltage at 60%RH. The sensor itself is not influenced by humidity. The phenomenon observed in Figure 6 is the result of the influence of humidity on O<sub>2</sub> concentration in air, as indicated in Figure 7.

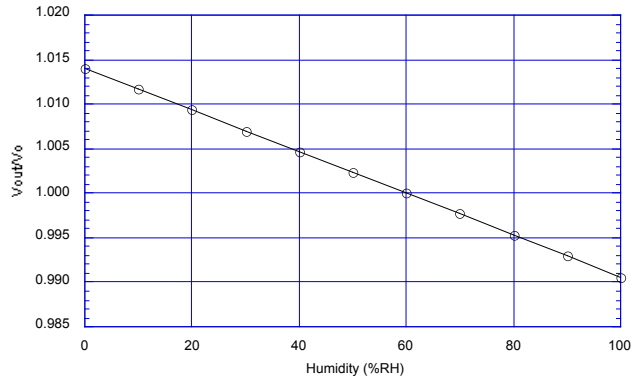

Fig. 6 - SK-25F effect of humidity on output voltage (at 25°C in ambient air)

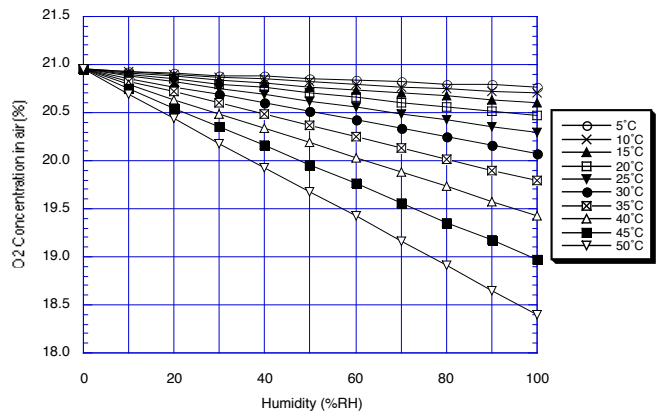

Fig. 7 - Effect of humidity on O<sub>2</sub> concentration in air

2-6 Temperature dependency

The SK-25F has a built-in temperature compensation circuit which uses a thermistor that is mounted inside the sensor's body (see Fig. 1). The temperature dependency of SK-25F with this built-in compensation circuit is shown in Fig. 8.

SK-25F may show some transient characteristics if the ambient temperature changes very widely and quickly. This is caused by the difference in response speed to temperature changes between the sensor compartment and the built-in thermistor. A quick rise in ambient temperature temporarily makes output voltage low and vice versa for a quick fall in temperature. Such temporary drift disappears after the sensor's temperature reaches equilibrium with the ambient temperature. For avoiding this problem, the sensor should be protected from quick temperature changes (such as direct exposure to sunlight or wind) by some kind of enclosure.

In addition, temperature should be kept uniform throughout the sensor's structure in order to avoid improper compensation caused by differences in temperature between the sensing area and the thermistor location.

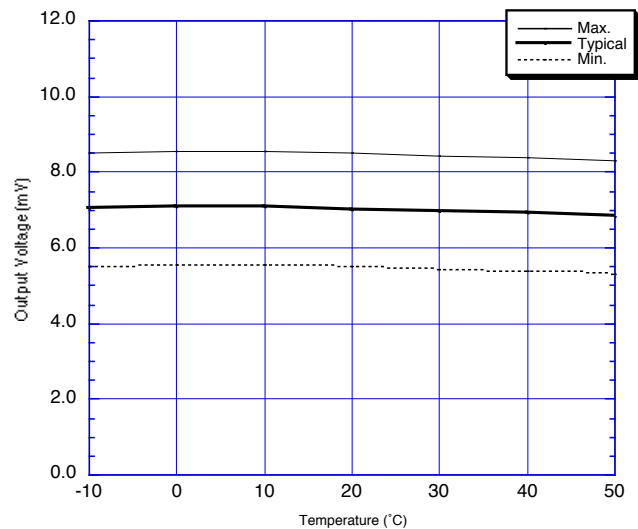

Fig. 8 - SK-25F temperature dependency of output voltage

### 3. Reliability

#### 3-1 Influence of organic solvents

Exposure to organic solvents such as toluene, benzene, xylene, acetone, methyl ethyl ketone, methyl chloride, kerosene, gasoline, naphtha and gas oil may cause the sensor's external housing (ABS resin) to degenerate and degrade, resulting in unstable output voltage. Condensation of such solvents on the sensor would cause adverse influence on output voltage and response speed. To reduce potential risk of exposure to these solvents, installation of a filter on the sensor is recommended.

#### 3-2 Life expectancy

The life expectancy of SK-25F is expressed in %-hours as follows:

$$[\text{Oxygen Concentration (\%)}] \times [\text{Exposure Time (hours)}]$$

Accordingly, the life of SK-25F is approximately 540,000 %-hours. The end of life for SK-25F is specified as the point at which output voltage is reduced to 60% from the initial output voltage of the sensor. These facts indicate that the expected life time in ambient conditions (21% O<sub>2</sub> at 20°C) is 3 years for SK-25F.

##### a) Relationship between expected life and O<sub>2</sub> concentration

Figure 9a shows the relationship between life expectancy and O<sub>2</sub> concentration for SK-25F. The Y-axis indicates the ratio of life expectancy in a given O<sub>2</sub> concentration (L) to life expectancy at 20.7% O<sub>2</sub> (L<sub>0</sub>). The greater the O<sub>2</sub> concentration, the shorter the life expectancy. The influence of atmospheric pressure on life expectancy is estimated based on the O<sub>2</sub> concentration in a given atmospheric pressure.

##### b) Relationship between expected life and storage temperature

Figure 9b shows the relationship between life expectancy and ambient temperature. The Y-axis indicates the ratio of life expectancy at a given temperature (L) compared to life expectancy at 20°C (L<sub>0</sub>). A correlation exists between the sensor's life time and its storage temperature—the life time becomes shorter as the storage temperature increases.

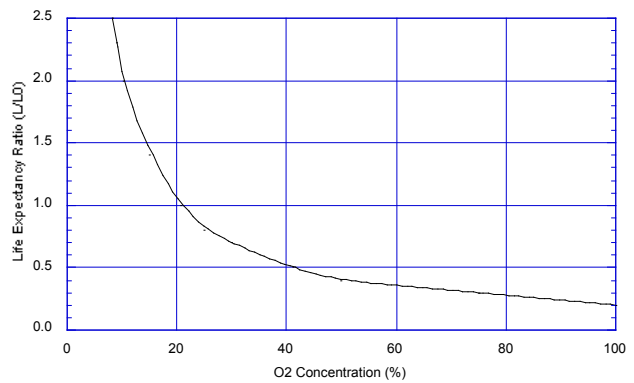

Fig. 9a - Relationship of life expectancy vs. O<sub>2</sub> concentration (L<sub>0</sub> = life at 20.7% O<sub>2</sub>)

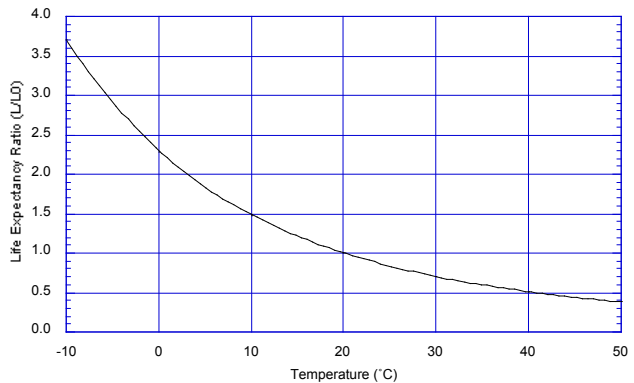

Fig. 9b - Relationship of life expectancy vs. ambient temperature (L<sub>0</sub> = life at 20°C)

### 3-3 Long term stability

When used in normal indoor air at uncontrolled ambient temperatures without any incidence of improper use, SK-25F shows good long term characteristics as illustrated in Fig.10.

*Please note that there are various factors which may influence the life time of SK-25F in actual use and that their life span can be variable.*

## 4. Handling Instructions

### 4-1 Required oxygen amount

SK-25F consumes a small amount of oxygen during the detection process. It is recommended that these sensors be used under conditions where the air exchange is greater than 2ml per minute to offset the sensor's oxygen consumption. Please note that sensors should be used under conditions where the air exchange is greater than 200ml per minute in order to obtain response speed specified in Table 1.

### 4-2 Mechanical strength against shock and vibration

Since mechanical shock and vibration may potentially influence the sensitivity characteristics of the sensor, these factors should be avoided in actual usage. Temporary changes/instability in the sensor's output signal may result due to these factors, but the signal may recover to its original state after the sensor is kept motionless in natural air/room temperature for between several hours to several days. If the mechanical shock or vibration is great, an irreversible change in the output signal may occur due to structural damage within the sensor. Shock absorbing measures should be used to protect the sensor during transportation or when used for applications in which shock/vibration is likely to occur.

### 4-3 Low O<sub>2</sub> concentration detection

When less than 1% O<sub>2</sub> is measured, offset voltage (which appears at close to 0% of O<sub>2</sub>) should be taken into consideration when calculating O<sub>2</sub> concentration. For details, please refer to the document *Application Notes on Offset Voltage and Low Concentration Measurement*.

### 4-4 Storage conditions

To prolong the life expectancy of SK-25F, storage at low temperature (in a refrigerator) and at low oxygen concentration is recommended. *Care should also be taken to ensure that the lead pins are not connected or shorted during storage as this may cause slow response*

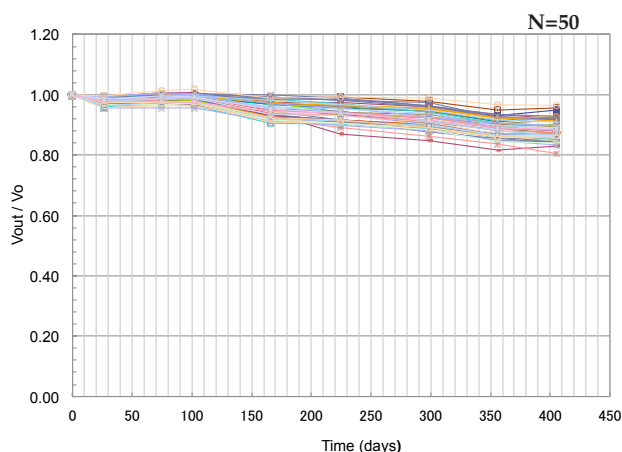

Fig. 10 - SK-25F long term stability

*to oxygen.*

If the sensor is stored in a 0% O<sub>2</sub> environment for an extended period of time, the sensor's offset voltage (see Sec. 4-3) becomes lower and response speed to O<sub>2</sub> will become slower. In this case, the sensor will be able to recover to normal response speed after exposure to a normal environment for a period of 24 hours. However, if the sensor is stored in such a condition for 3 days or longer, sensor characteristics may not recover to the original state.

At -10~-20°C, the electrolyte will freeze and the sensor will not function, but SK-25F would not be damaged by freezing of the electrolyte in this range and will resume functioning after the electrolyte thaws to a liquid state. Below -20°C, the sensor may be damaged by freezing of the electrolyte, resulting in possible leakage of the electrolyte.

At temperatures higher than 60°C, the sensor life may become shorter than the specification due to evaporation of the electrolyte.

### 4-5 Influence of condensation

Measures should be taken to prevent condensation on the sensor because the output signal will degrade and response speed will decrease, causing inaccurate measurement. However, once condensation dissipates, sensor characteristics will recover to their original state.

### 4-6 Recommended input impedance

The sensor must be connected to equipment which has an input impedance of 1000kΩ or greater. If not, proper temperature compensation would not be possible.

### 4-7 Sensor connection

The sensor must not have a counter-electromotive force applied to it from any equipment to which it is connected. Application of external electric potential to the sensor's output terminals may cause temporary instability in the output signal and reduced response speed. However, removal of this condition and subsequent aging in normal air for several days will allow the sensor to recover to normal.

If reverse polarity or excessive voltage is applied to the sensor, the characteristic change would be irreversible due to the internal electrical damage caused by this condition. For example, if several 10mV of reverse voltage were applied, the internal electrode would be broken.

### 4-8 Safety measures for electrolyte leakage

If the liquid electrolyte leaks due to sensor breakage, care should be taken in handling the sensor, which should immediately be placed into a plastic bag. The liquid electrolyte is a weak aqueous acid solution (pH=5~6) with an irritating odor. The liquid is non-flammable. Since this solution contains lead acetate, which is harmful to humans, contact with this liquid should be avoided.

In case the liquid electrolyte contacts the skin or clothing, wash with soapy water and rinse generously with plain water. If the liquid electrolyte contacts the eye, flush with water for at least 15 minutes and obtain immediate medical assistance. In case of breathing in of the electrolyte, flush the nasal cavity thoroughly with water and seek immediate medical assistance. If the electrolyte is swallowed, rinse the mouth thoroughly with water and seek immediate medical assistance.

### 4-9 Soldering

The sensor pins should not be soldered since the internal structure may be damaged by the heat of soldering. Pin sockets should be used for sensor connection.

### 4-10 Sensor label

The sensor label covering the sensor body should not be removed since the label is used to prevent evaporation of electrolyte from the sensor body.

### 4-11 Sensor tape

When the sensor is shipped, blue tape covers the gas diffusion holes to minimize consumption of the

sensor life during storage. Before measuring sensor output, the tape should be removed.



## 5. Warranty

The SK-series oxygen sensors shall be warranted for 12 months after the date of purchase from Figaro.

Provided that return of the sensor to Figaro is made within the warranty period, if it is determined upon reasonable inspection tests that any of the following defects exists, returned sensors will be replaced free of charge with a new sensor of the identical model.

1) The output voltage of the sensor in normal air at  $25^{\circ}\text{C}\pm 1^{\circ}\text{C}$ ,  $60\pm 5\%\text{RH}$  and atmospheric pressure of  $1013\pm 5\text{hPa}$  is 70% or less than the initial output voltage under the standard test conditions.

2) The output voltage change is not proportional to the change in oxygen concentration.

THIS WARRANTY SHALL NOT APPLY TO ANY KE-SERIES PRODUCTS OR PORTIONS THEREOF WHICH HAVE BEEN SUBJECTED TO ABUSE, MISUSE, IMPROPER INSTALLATION, STORAGE OR MAINTENANCE, OR IMPROPER OPERATION UNDER THE CONDITIONS WHICH DEVIATE SIGNIFICANTLY FROM NORMAL AMBIENT AIR AND TEMPERATURE.

---

Figaro reserves the right to make changes without notice to any products herein to improve reliability, functioning or design. Information contained in this document is believed to be reliable. However, Figaro does not assume any liability arising out of the application or use of any product or circuit described herein; neither does it convey any license under its patent rights, nor the rights of others.

Figaro's products are not authorized for use as critical components in life support applications wherein a failure or malfunction of the products may result in injury or threat to life.



**FIGARO GROUP**

**HEAD OFFICE**

**Figaro Engineering Inc.**  
1-5-11 Senba-nishi  
Mino, Osaka 562-8505 JAPAN  
Tel.: (81) 72-728-2561  
Fax: (81) 72-728-0467  
email: [figaro@figaro.co.jp](mailto:figaro@figaro.co.jp)  
[www.figaro.co.jp](http://www.figaro.co.jp)

**OVERSEAS**

**Figaro USA Inc.**  
121 S. Wilke Rd. Suite 300  
Arlington Heights, IL 60005 USA  
Tel.: (1) 847-832-1701  
Fax: (1) 847-832-1705  
email: [figarousa@figarosensor.com](mailto:figarousa@figarosensor.com)  
[www.figarosensor.com](http://www.figarosensor.com)