

FIGARO

an ISO9001 company

Technical Information for Combination Methane and Carbon Monoxide Sensors

The Figaro TGS3870-B00 sensor is a small bead-type metal oxide semiconductor. The sensor's miniature size and cyclic heater operation enable its single sensing element to be highly selective to both carbon monoxide and methane and to show low power consumption.



| <i>Specifications</i> | <i>Page</i> |
|--|-------------|
| Features..... | 2 |
| Applications..... | 2 |
| Structure..... | 2 |
| Specifications..... | 3 |
| Dimensions..... | 3 |
| Standard Test Conditions..... | 4 |
| Basic Measuring Circuit..... | 4 |
| <i>Basic Sensitivity Characteristics</i> | |
| Sensitivity to Various Gases..... | 4 |
| Temperature Dependency..... | 5 |
| Humidity Dependency..... | 6 |
| Gas Response..... | 6 |
| Initial Action..... | 7 |
| Long-Term Stability..... | 7 |
| <i>Reliability</i> | |
| False Alarm Test..... | 8 |
| Influence of Silicone Gas..... | 9 |
| Corrosion Test..... | 10 |
| Variable Ambient Temperature Test..... | 11 |
| Temperature Cycle Test..... | 12 |
| <i>Cautions</i> | 12 |
| <i>See also Technical Brochure "Technical Information on Usage of TGS Gas Sensors for Explosive/Toxic Gas Alarming".</i> | |

IMPORTANT NOTE: OPERATING CONDITIONS IN WHICH FIGARO SENSORS ARE USED WILL VARY WITH EACH CUSTOMER'S SPECIFIC APPLICATIONS. FIGARO STRONGLY RECOMMENDS CONSULTING OUR TECHNICAL STAFF BEFORE DEPLOYING FIGARO SENSORS IN YOUR APPLICATION AND, IN PARTICULAR, WHEN CUSTOMER'S TARGET GASES ARE NOT LISTED HEREIN. FIGARO CANNOT ASSUME ANY RESPONSIBILITY FOR ANY USE OF ITS SENSORS IN A PRODUCT OR APPLICATION FOR WHICH SENSOR HAS NOT BEEN SPECIFICALLY TESTED BY FIGARO.



TGS3870 is a UL recognized component in accordance with the requirements of UL2075. Please note that component recognition testing has confirmed long term stability in 60ppm of methane and 15ppm of carbon monoxide; other characteristics shown in this brochure have not been confirmed by UL as part of component recognition.

1. Specifications

1-1 Features

- * Miniature size and low power consumption
- * High sensitivity and selectivity to both methane and carbon monoxide (CO)
- * Low sensitivity to alcohol vapor
- * Long life and low cost

1-2 Applications

- * Combination methane and CO detectors

1-3 Structure

Figure 1 shows the structure of TGS3870-B00. A heater coil and an electrode are embedded in a small bead of SnO₂ sensing material. The heater is connected to pin Nos. 1 and 3 while the electrode is connected to pin No. 2. Both the heater and the electrode are composed of Pt wire and are spot welded to sensor pins (made of Ni-Fe 42% alloy).

The sensor base is made of PBT (poly butylene terephthalate), and the sensor cap is made of

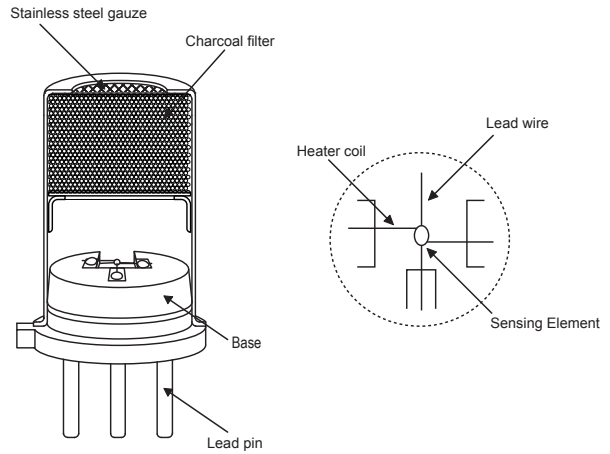

Figure 1 - Sensor structure

stainless steel. The upper opening in the cap is covered with a double layer of 100-mesh stainless steel gauze (SUS316) and the sensor cap also has an activated charcoal filter for reducing the influence of interference gases.

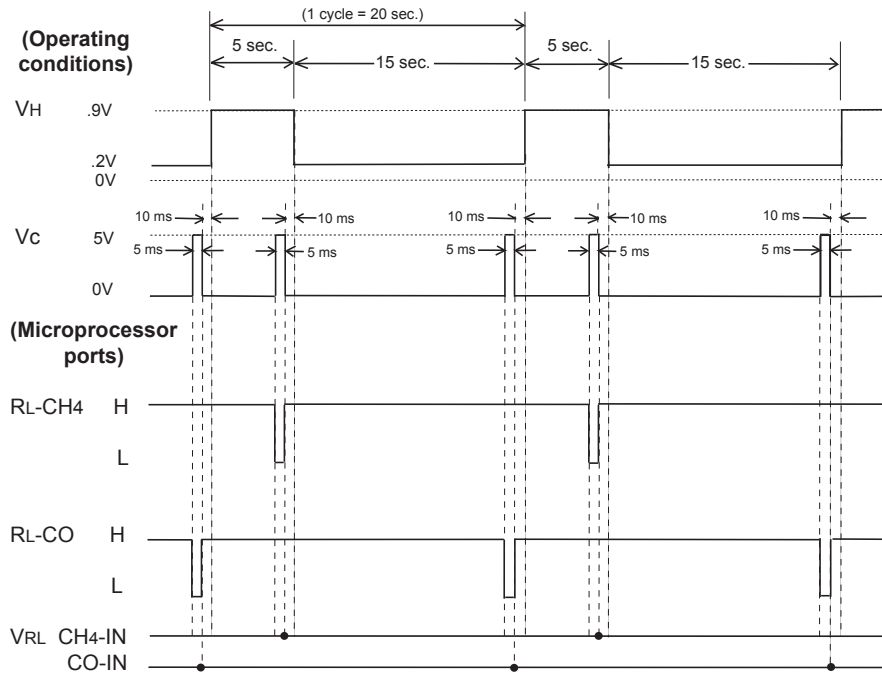

Figure 2 - Timing chart

1-4 Specifications

| | | | |
|---|---------------------------------|---|--|
| Model number | | TGS3870-B00 | |
| Sensing principle | | MOS type | |
| Standard package | | Plastic base and metal can | |
| Target gases | | Methane and Carbon Monoxide | |
| Typical detection range | | Methane 1~25% LEL Carbon monoxide 50~1,000ppm | |
| Standard circuit conditions | Heater voltage | V _H | V _H H = 0.9V±3% for 5 sec. V _H L = 0.2V±3% for 15sec. |
| | Circuit voltage | V _C | 5.0±0.2V DC pulse <i>(refer to Technical Information for TGS3870-B00)</i> |
| | Load resistance | R _L | variable (>0.75kΩ) |
| Electrical characteristics under standard test conditions | Heater resistance | R _H | 3Ω±0.3Ω at room temp. |
| | Heater power consumption | P _H | 120mW V _H H = 0.9V DC |
| | | | 11mW V _H L = 0.2V DC |
| | | | 38mW average |
| | Sensor resistance | R _S | 0.35kΩ~3.5kΩ in 3000ppm methane |
| 1.8kΩ~24kΩ in 150ppm CO | | | |
| Sensitivity (change ratio of R _S) | β | 0.50~0.65 R _S (3000ppm CH ₄) R _S (1000ppm CH ₄) | |
| | | 0.1~0.6 R _S (300ppm CO) R _S (150ppm CO) | |
| Standard test conditions | Test gas conditions | Target gas in air at 20±2°C, 65±5%RH | |
| | Circuit conditions | V _H H = 0.9V±2% for 5 sec. V _H L = 0.2V±2% for 15 sec. V _C = 5.0±0.02V DC pulse <i>(refer to Technical Information for TGS3870-B00)</i> | |
| | Conditioning period before test | ≥5 days | |

NOTE: Caution should be exercised in the selection of the load resistor (R_L) to ensure that power consumption (P_S) does **not** exceed 15mW.

$$P_s = (V_s)^2/R_s$$

P_S reaches max. value when: R_L = R_S

Sensor resistance (R_S) is calculated with a measured value of V_{RS} by using the following formula:

$$R_s = \frac{(V_{RS} - 0.5V_H)}{(V_C - V_{RS})} \times R_L$$

Mechanical Strength:

The sensor shall have no abnormal findings in its structure and shall satisfy the above electrical specifications after the following performance tests:

Withdrawal Force - withstand force of 5kg in each (pin from base) direction

Vibration - vertical amplitude=1.5mm, frequency=10~500Hz, duration=3 hours, direction=x,y,z (all)

Shock - acceleration-100G, repeat 5 times

1-5 Dimensions

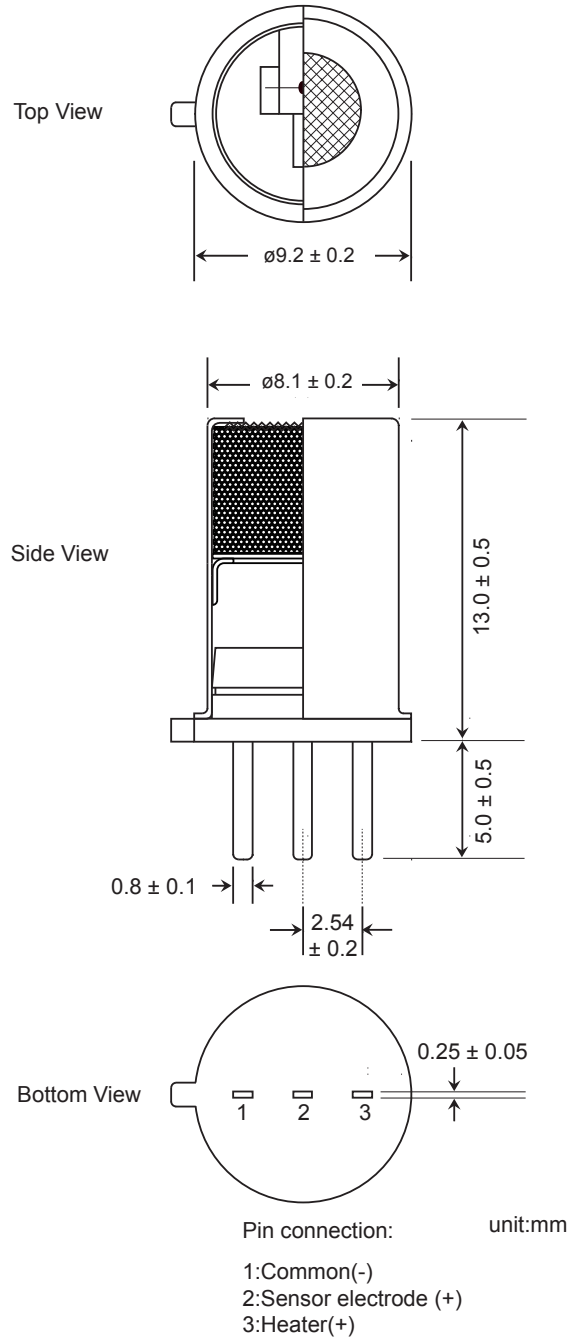

Figure 3 - Dimensions

All sensor characteristics shown in this brochure represent typical characteristics. Actual characteristics vary from sensor to sensor and from production lot to production lot. The only characteristics warranted are those shown in the Specification table above.

1-6 Standard test conditions

Standard test conditions for all data shown in this brochure were as follows:

- Preheating of sensor: 5 days
- VH (H/L): 0.9V/0.2V (see timing chart, Fig. 2)
- VC: 5.0V pulse (see timing chart, Fig. 2)

1.7 Basic measuring circuit

The sensor requires two voltage inputs: heater voltage (VH) and circuit voltage (VC). The sensor has three pins: Pin #3--heater (+), Pin #2--sensor electrode (+), and Pin #1--common (-). To maintain the sensing element at specific temperatures which are optimal for sensing two different gases, heater voltages of 0.9V and 0.2V are alternately applied between pins #1 and #3 during a 20 second heating cycle (see Fig. 2).

Circuit voltage (VC) is applied between both ends of the sensor (Rs) and a load resistor (RL), which are connected in series, to allow measurement of voltage (VRS) as shown in Figure 4.

Circuit voltage (Vc) should be applied only at the moment when the signal is taken from the sensor (please refer to Fig. 2):

- *for methane--5.0V for 5msec. following VH of 0.9V for 4.985 sec.
- *for CO--5.0V for 5 msec. following VH of 0.2V for 14.985 sec.

Caution: Do not apply a constant circuit voltage (5.0V) or the sensor would not exhibit its specified characteristics.

2. Basic Sensitivity Characteristics

2-1 Sensitivity to various gases

Figures 5a and 5b show the sensor's relative sensitivity to various gases. Figure 5a shows the characteristics for methane sensing, while Figure 5b shows the characteristics for sensing of CO. The Y-axis for each figure shows the ratio of sensor resistance in various gases (Rs) to the sensor resistance in 3000ppm of methane (Fig. 5a) and in 100ppm of CO (Fig. 5b).

As shown by Figure 5a, TGS3870-B00 shows very good sensitivity to methane and good selectivity when compared with hydrogen.

Excellent sensitivity to CO is shown in Figure 5b as evidenced by the sharp drop in sensor resistance as CO concentration increases. Selectivity is also quite

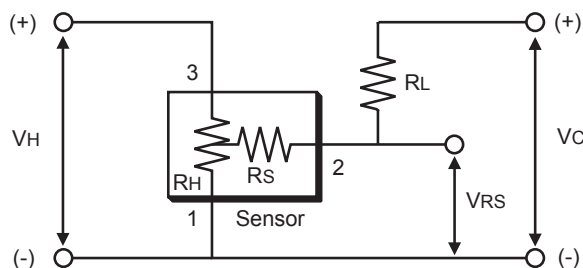

Figure 4 - Basic measuring circuit

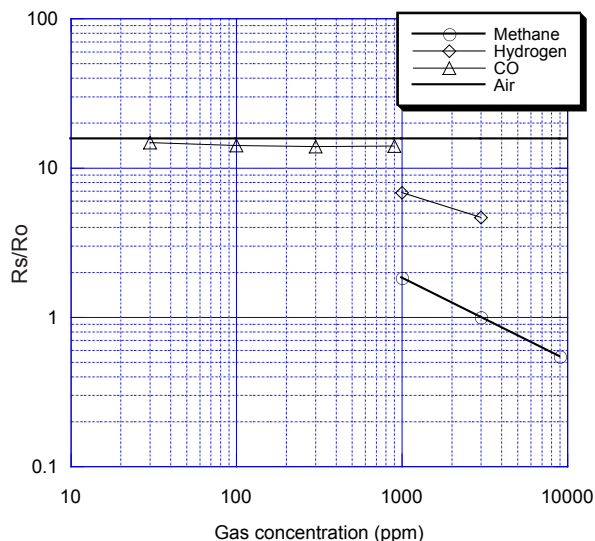

Figure 5a - Sensitivity to various gases for methane sensing (Ro = Rs in 3000ppm of CH4, VH =0.9)

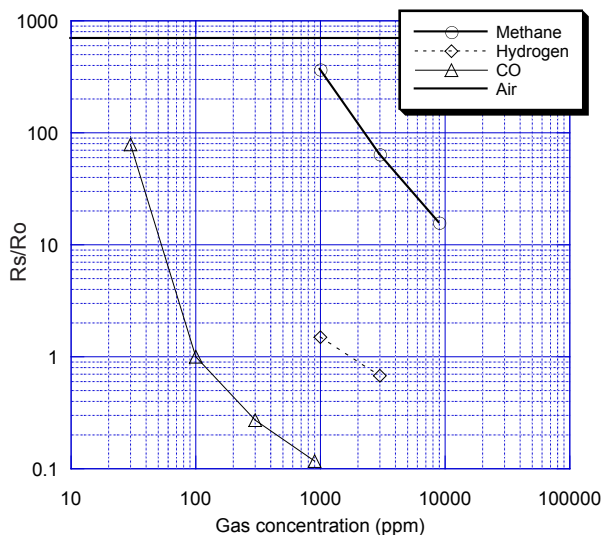

Figure 5b - Sensitivity to various gases for CO sensing (Ro = Rs in 100ppm of CO, VH =0.2)

good. In comparison to CO, sensitivity to hydrogen is very low as indicated by the extremely high concentrations of hydrogen required to approximate very low CO levels. Cross-sensitivity to methane is very low according to its high resistance values.

2-2 Temperature dependency

Figures 6a and 6b show the temperature dependency of TGS3870-B00. The Y-axis shows the ratio of sensor resistance for gas concentrations under various atmospheric conditions (R_s) to the sensor resistance at 20°C and 65%RH (R_o) for 3000ppm of methane (Fig. 6a) and for 100ppm of CO (Fig. 6b).

An inexpensive way to compensate for temperature dependency would be to incorporate a thermistor in the detection circuit. Separate compensation circuits should be prepared for CO and methane sensing.

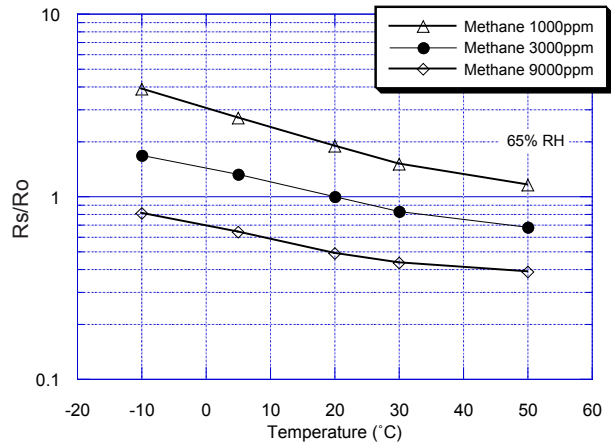

Figure 6a - Temperature dependency for methane sensing ($R_o = R_s$ in 3000ppm of CH_4 at 20°C/65%RH, $V_H=0.9$)

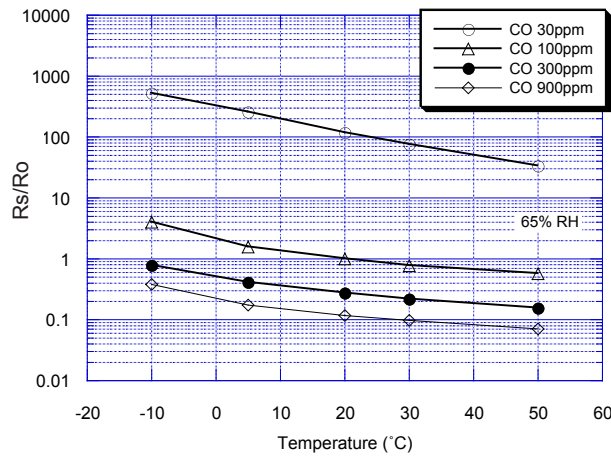

Figure 6b - Temperature dependency for CO sensing ($R_o = R_s$ in 100ppm of CO at 20°C/65%RH, $V_H=0.2$)

2-3 Humidity dependency

Figures 7a and 7b show the humidity dependency of TGS3870-B00. The Y-axis shows the ratio of sensor resistance for gas concentrations under various atmospheric conditions (R_s) to the sensor resistance at 20°C and 65%RH (R_o) for 3000ppm of methane (Fig. 7a) and for 100ppm of CO (Fig. 7b).

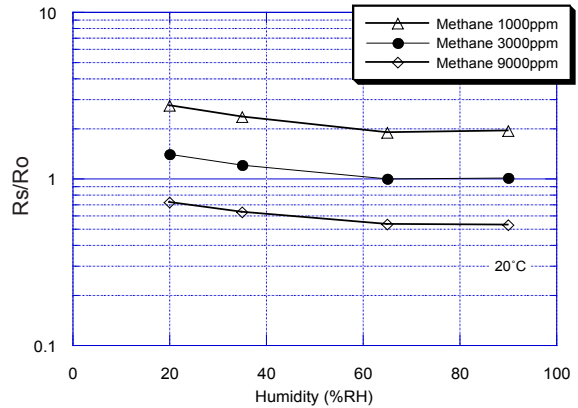

Figure 7a - Humidity dependency for methane sensing ($R_o = R_s$ in 3000ppm of CH_4 at 20°C/65%RH, $V_H = 0.9$)

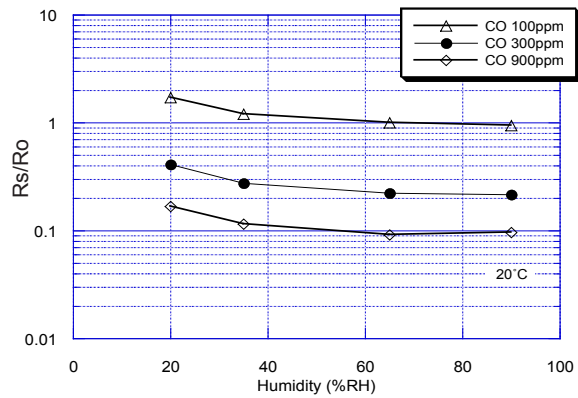

Figure 7b - Humidity dependency for CO sensing ($R_o = R_s$ in 100ppm of CO at 20°C/65%RH, $V_H = 0.2$)

2-4 Gas response

Figures 8a and 8b show the change patterns of sensor resistance (R_s) when the sensor is inserted into and later removed from 3000ppm of methane and 100ppm of carbon monoxide respectively. Measurements were taken every 20 seconds.

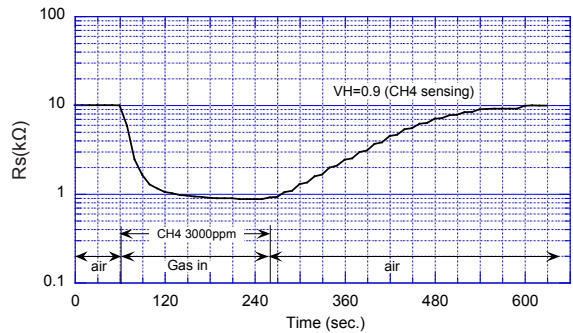

Figure 8a - Gas response speed - methane

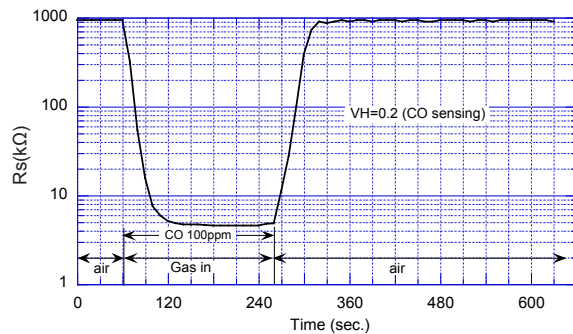

Figure 8b - Gas response speed - CO

2-5 Initial action

Figures 9a and 9b demonstrate the initial action of sensor resistance (R_s) for a sensor which has been stored unenergized in normal air at 50°C/60%RH. The R_s drops sharply for the first few seconds after energizing, regardless of the presence of gas, and then reaches to a stable level according to the ambient atmosphere. Such behavior during the warm-up process is referred to as ‘initial action’. Since this initial action may cause a detector to alarm unnecessarily during the first moments after powering on, it is recommended that an initial delay circuit be incorporated into the detector’s design (refer to Technical Advisory *Technical Information on Usage of TGS Sensors for Toxic and Explosive Gas Leak Detectors*). This is especially recommended for intermittent operation devices such as portable gas detectors.

2-6 Long-term stability

Figures 10a and 10b show long-term stability data for TGS3870-B00. Test samples were energized in normal air and under standard circuit conditions (see p.4). Measurement for confirming sensor characteristics was conducted under standard test conditions (20°C, 65%RH). The initial value was measured after two days of energizing in normal air at standard test conditions (see p.4). The Y-axis shows the ratio between measured sensor resistance and the initial (Day 0) resistance value in 3000ppm of methane (Fig. 10a) and in 100ppm of CO (Fig. 10b).

The characteristics for both CO and methane sensing are very stable for more than 650 days.

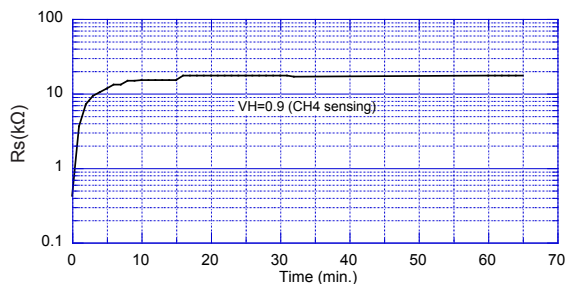

Figure 9a - Initial action - methane

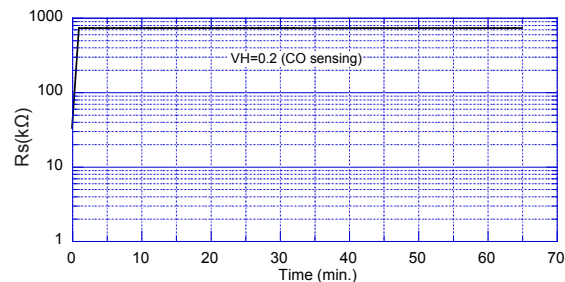

Figure 9b - Initial action - CO

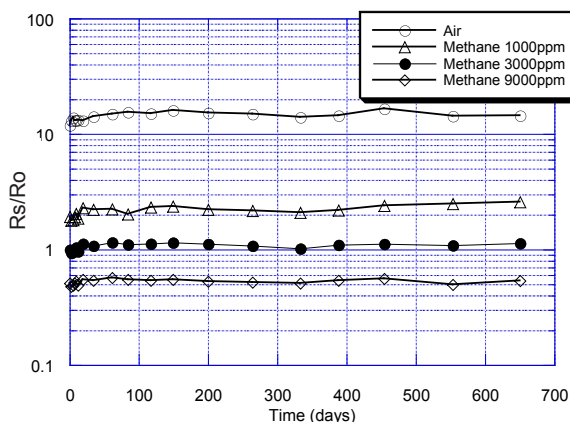

Figure 10a - Long term stability for methane sensing (Ro = Rs in 3000ppm of CH₄ at Day=0, VH =0.9)

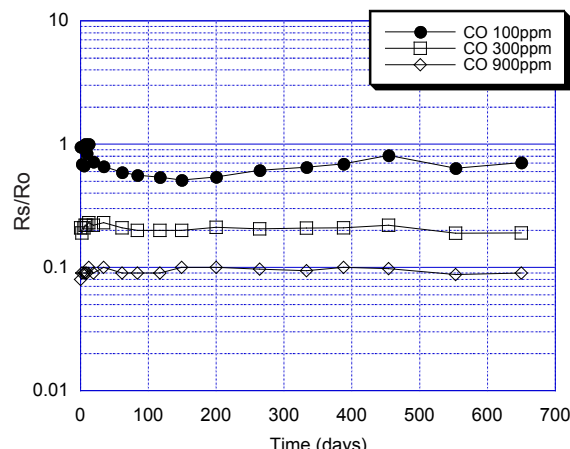

Figure 10b - Long term stability for CO sensing (Ro = Rs in 100ppm of CO at Day=0, VH =0.2)

3. Reliability

3-1 False alarming test

To demonstrate the sensor's behavior under continuous low level exposure to CO, samples were tested according to the procedure detailed in UL2034, Sec. 41.1(c)-Stability Test. Test samples were exposed to 30ppm of CO continuously for 30 days under standard circuit conditions. As this data shows, no significant change can be seen in CO and methane sensing characteristics as a result of continuous low level exposure to CO.

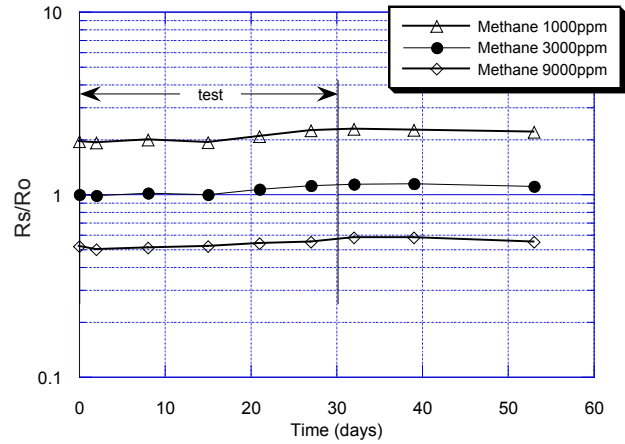

Figure 11a - Effects of exposure to 30ppm CO for 30 days (Ro= Rs in 3000ppm methane prior to CO exposure, VH =0.9)

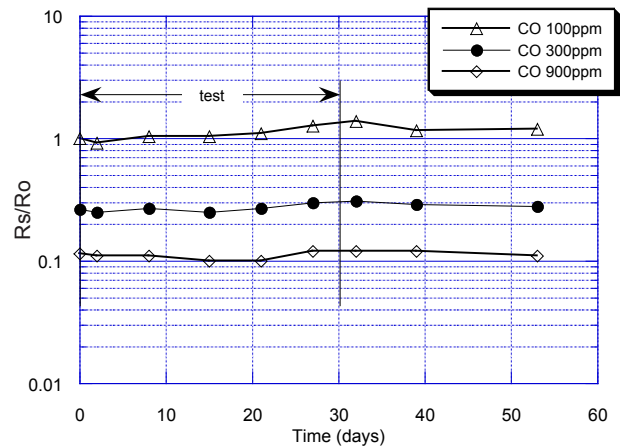

Figure 11b - Effects of exposure to 30ppm CO for 30 days (Ro= Rs in 100ppm CO prior to CO exposure, VH =0.2)

3-2 Influence of silicone gas

Figures 12a and 12b show the behavior of sensor resistance (R_s) when the sensor is exposed to 10ppm of hexamethyldisiloxane (HMDS) gas. (The test concentration was selected by referencing Item 5.3.13 of European Standard EN50194.)

Sensor resistance was measured prior to HMDS exposure (R_o), after which energized sensors were placed into an environment of 20°C and 65%RH. In this environment, sensors were exposed to 10ppm HMDS for a period of 1 hour. After this exposure, sensors were returned to normal air and measurements in the listed gases were taken.

As this data shows, TGS3870-B00 possesses durability to HMDS exposure.

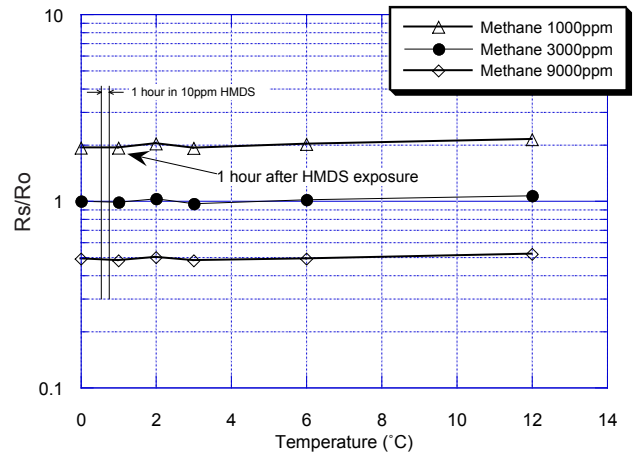

Figure 12a - Influence of silicone gas exposure on methane sensing
($R_o=R_s$ in 3000ppm methane prior to HMDS exposure, $V_H=0.9$)

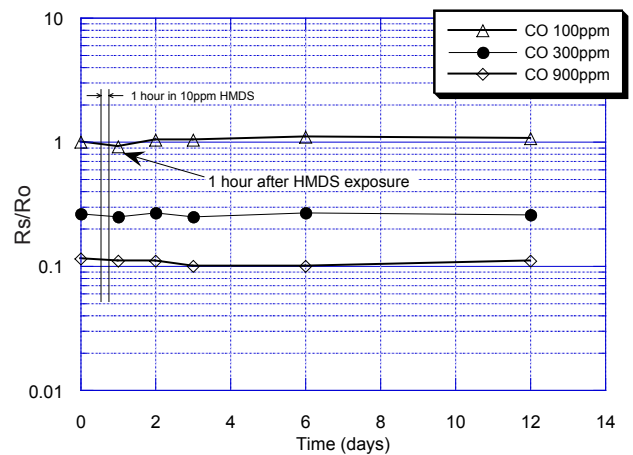

Figure 12b - Influence of silicone gas exposure on CO sensing
($R_o=R_s$ in 100ppm CO prior to HMDS exposure, $V_H=0.2$)

3-3 Corrosion test

To demonstrate the durability of TGS3870-B00 against corrosion, samples were subjected to test conditions called for by UL2034, Sec. 57-Corrosion Test. Over a three week period, a mixture of H₂S 100ppb, Cl₂ 20ppb, and NO₂ 200ppb was supplied to the sensor at a rate sufficient to achieve an air exchange of 5 times per hour. Measurements in the listed gases were taken one hour after sensors were temporarily removed from the test mixture and returned to normal air.

No significant effects can be seen on the CO sensing characteristics of the sensor during and after this test, while methane sensing characteristics were unaffected by this test.

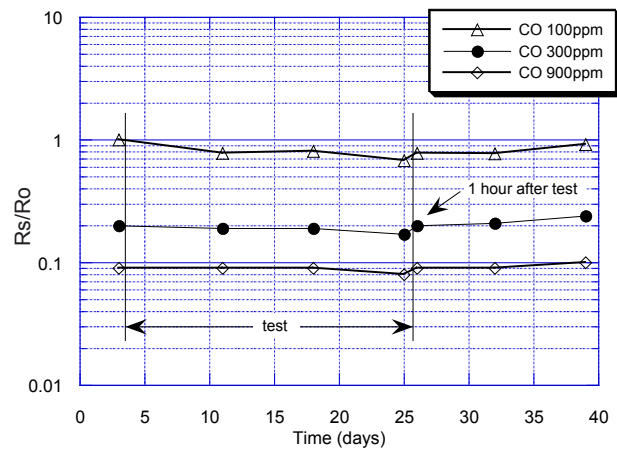
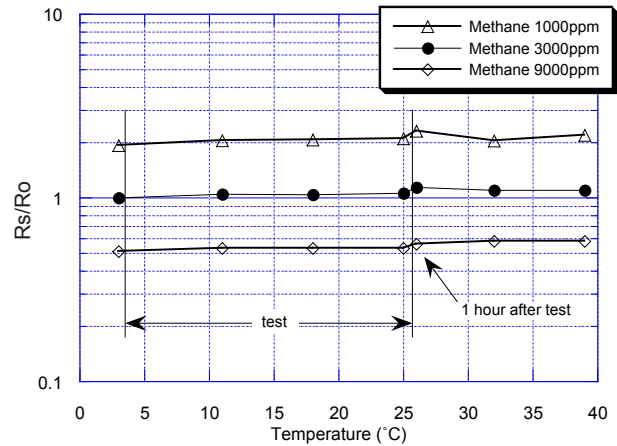

Figure 13b - Corrosion durability for CO sensing (Ro = Rs in 100ppm of CO prior to test, V_H = 0.2)

3-4 Variable ambient temperature test

To show the ability of TGS3870-B00 to withstand the effects of high and low temperatures representative of shipping and storage, the sensor was subjected to the conditions of UL2034 Sec. 44.2-Effect of Shipping and Storage. Unenergized test samples were subjected to 70°C for 24 hours, allowed to cool in room temperature for 1 hour, subjected to -40°C for 3 hours, and then allowed to warm up to room temperature for 3 hours.

No significant effects can be seen on the CO sensing characteristics of the sensor during and after this test, while methane sensing characteristics were unaffected by this test.

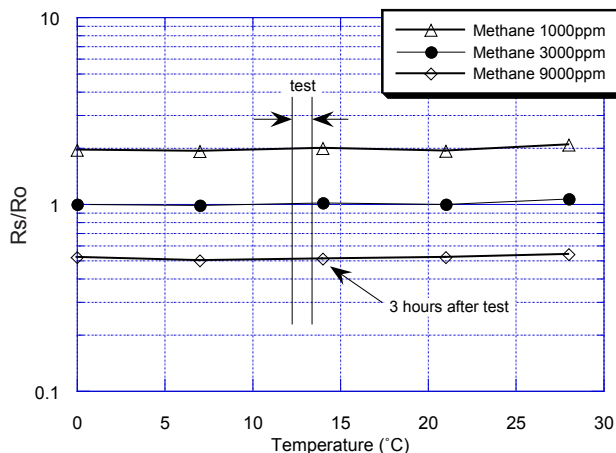

Figure 14a - Effects of variable ambient temperature test on methane sensing
($R_o = R_s$ in 3000ppm of CH_4 at Day=0, $V_H = 0.9$)

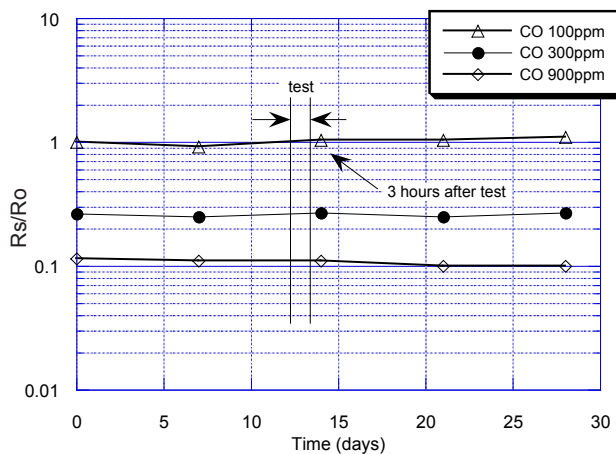

Figure 14b - Effects of variable ambient temperature test on CO sensing
($R_o = R_s$ in 100ppm of CO at Day=0, $V_H = 0.2$)

3-5 Temperature cycle test

In accordance with UL2034, Sec. 41.1(e)-Stability Test, test samples were exposed to ten cycles (<1 hour and > 15 minutes) of temperature from 0°C and 100%RH to 49°C and 40%RH. As the two test measurements taken 8 hours after the conclusion of the test period demonstrate, sensors subjected to this test show negligible influence on CO and methane sensing by temperature extremes.

4. Cautions

4-1 Situations which must be avoided

- 1) Exposure to silicone vapors
If silicone vapors adsorb onto the sensor's surface, the sensing material will be coated, irreversibly inhibiting sensitivity. Avoid exposure where silicone adhesives, hair grooming materials, or silicone rubber/putty may be present.
- 2) Highly corrosive environment
High density exposure to corrosive materials such as H₂S, SO_x, Cl₂, HCl, etc. for extended periods may cause corrosion or breakage of the lead wires or heater material.
- 3) Contamination by alkaline metals
Sensor drift may occur when the sensor is contaminated by alkaline metals, especially salt water spray.
- 4) Contact with water
Sensor drift may occur due to soaking or splashing the sensor with water.
- 5) Freezing
If water freezes on the sensing surface, the sensing material would crack, altering characteristics.
- 6) Application of excessive voltage
If higher than specified voltage is applied to the sensor or the heater, lead wires and/or the heater may be damaged or sensor characteristics may drift, even if no physical damage or breakage occurs.
- 7) Operation in zero/low oxygen environment
TGS sensors require the presence of around 21% (ambient) oxygen in their operating environment in order to function properly and to exhibit characteristics described in Figaro's product literature. TGS sensors cannot properly operate in a zero or low oxygen

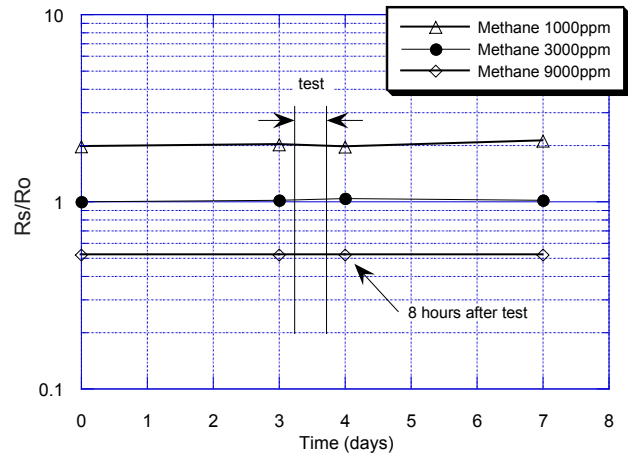

Figure 15a - Temperature cycle test effects on methane sensing (Ro = Rs in 3000ppm of CH₄ at Day=0, V_H =0.9)

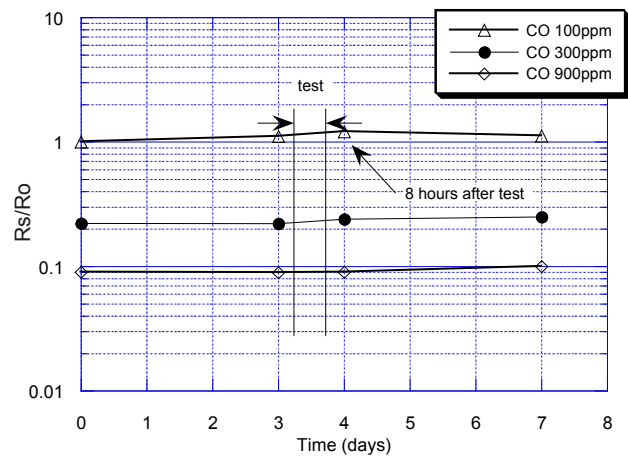

Figure 15b - Temperature cycle test effects on CO sensing (Ro = Rs in 100ppm of CO at Day=0, V_H =0.2)

content atmosphere.

8) Polarization

The sensor has polarity. An incorrect Vc connection may cause significant deterioration of long term stability. Connect Vc according to specifications.

9) Soldering

Sensors should be manually soldered--wave soldering is not recommended. The high heat generated during wave soldering may deform the resin parts and damage the sensor (e.g. the pressure-fitted sensor cap may separate from the base). For sensors with a filter cap (such as TGS3870-B00), deformation may create a gap between the sensor cap and base, allowing interference gases to bypass the filter.

4-2 Situations to be avoided whenever possible

1) Water condensation

Light condensation under conditions of indoor usage should not pose a problem for sensor performance. However, if water condenses on the sensor's surface and remains for an extended period, sensor characteristics may drift.

2) Usage in high density of gas

Sensor performance may be affected if exposed to a high density of gas for a long period of time, regardless of the powering condition.

3) Storage for extended periods

When stored without powering for a long period, the sensor may show a reversible drift in resistance according to the environment in which it was stored. The sensor should be stored in a sealed bag containing clean air; do not use silica gel. *Note that as unpowered storage becomes longer, a longer preheating period is required to stabilize the sensor before usage.*

4) Long term exposure in adverse environment

Regardless of powering condition, if the sensor is exposed in extreme conditions such as very high humidity, extreme temperatures, or high contamination levels for a long period of time, sensor performance will be adversely affected.

5) Vibration

Excessive vibration may cause the sensor or lead wires to resonate and break. Usage of compressed air drivers/ultrasonic welders on assembly lines may generate such vibration, so please check this matter.

6) Shock

Breakage of lead wires may occur if the sensor is subjected to a strong shock.

Figaro USA Inc. and the manufacturer, Figaro Engineering Inc. (together referred to as Figaro) reserve the right to make changes without notice to any products herein to improve reliability, functioning or design. Information contained in this document is believed to be reliable. However, Figaro does not assume any liability arising out of the application or use of any product or circuit described herein; neither does it convey any license under its patent rights, nor the rights of others.

Figaro's products are not authorized for use as critical components in life support applications wherein a failure or malfunction of the products may result in injury or threat to life.

FIGARO GROUP

HEAD OFFICE

Figaro Engineering Inc.

1-5-11 Senba-nishi
Mino, Osaka 562-8505 JAPAN
Tel.: (81) 72-728-2561
Fax: (81) 72-728-0467
email: figaro@figaro.co.jp
www.figaro.co.jp

OVERSEAS

Figaro USA Inc.

121 S. Wilke Rd. Suite 300
Arlington Heights, IL 60005
Tel.: (1) 847-832-1701
Fax.: (1) 847-832-1705
email: figarousa@figarosensor.com