

FIGARO

an ISO9001 company

Technical Information for Methane & LP Gas Sensors

The Figaro TGS6810-D00 catalytic type gas sensor, which can detect both methane and LP gas, has been developed for residential gas detection. This sensor features high accuracy, good durability and stability, quick response, and linear output, making them ideal for the detection of many combustible gases.



	<u>Page</u>
Basic Information and Specifications	
Features.....	2
Applications.....	2
Structure.....	2
Basic Measuring Circuit.....	2
Circuit & Operating Conditions.....	3
Specifications.....	3
Dimensions.....	3
Typical Sensitivity Characteristics	
Sensitivity to Various Gases.....	4
Temperature Dependency.....	4
Humidity Dependency.....	4
Heater Voltage Dependency.....	5
Gas Response.....	5
Initial Action.....	5
Reliability	
Long Term Characteristics.....	6
Durability to Hydrogen.....	6
Durability to Sulphur Dioxide.....	6
Durability to Nitrogen Dioxide.....	7
Durability to HMDS.....	7
Effects of Air Flow.....	7
Cautions	8

IMPORTANT NOTE: OPERATING CONDITIONS IN WHICH FIGARO SENSORS ARE USED WILL VARY WITH EACH CUSTOMER'S SPECIFIC APPLICATIONS. FIGARO STRONGLY RECOMMENDS CONSULTING OUR TECHNICAL STAFF BEFORE DEPLOYING FIGARO SENSORS IN YOUR APPLICATION AND, IN PARTICULAR, WHEN CUSTOMER'S TARGET GASES ARE NOT LISTED HEREIN. FIGARO CANNOT ASSUME ANY RESPONSIBILITY FOR ANY USE OF ITS SENSORS IN A PRODUCT OR APPLICATION FOR WHICH A SENSOR HAS NOT BEEN SPECIFICALLY TESTED BY FIGARO.

1. Basic Information and Specifications

1-1 Features

- * Linear output
- * Long life
- * Small sensitivity to alcohol
- * Sensitive to methane and LP gas

1-2 Applications

- * Residential LNG and LPG alarms
- * Detectors for LNG and LPG

1-3 Structure

Figure 1 shows the structure of TGS6810-D00. The sensor is comprised of two elements: element (D) which is sensitive to combustible gases, and a reference element (C) which does not have sensitivity to combustible gases. The sensing element (D) is made of alumina doped with catalysts, while the reference element (C) is made of alumina. Both coils are made of Pt wire, and the wires of both elements (D) and (C) are connected to nickel pins No. 2 & 3 and No. 1 & 4 respectively. The sensor base and cap are made of reinforced Polybutylene Terephthalate (PBT). The upper opening in the cap is covered with a double layer of 100 mesh stainless steel gauze (SUS316). The TGS6810-D00 utilizes a zeolite filter inside the cap for reducing the influence of interference gases.

1-4 Basic measuring circuit

The TGS6810 is comprised of two elements: 1) element (D) which is sensitive to combustible gases and 2) a reference element (C) which is not sensitive to combustible gases. These elements are installed into a "Wheatstone Bridge". A variable resistor should be adjusted so that the bridge will produce a stable baseline signal when in an environment free of combustible gases. When combustible gases are present, they will be combusted on the detecting element, causing its temperature to rise. Accordingly the resistance of this element will increase. This results in an "out-of-balance" signal across the bridge and a corresponding change in output voltage which can be measured.

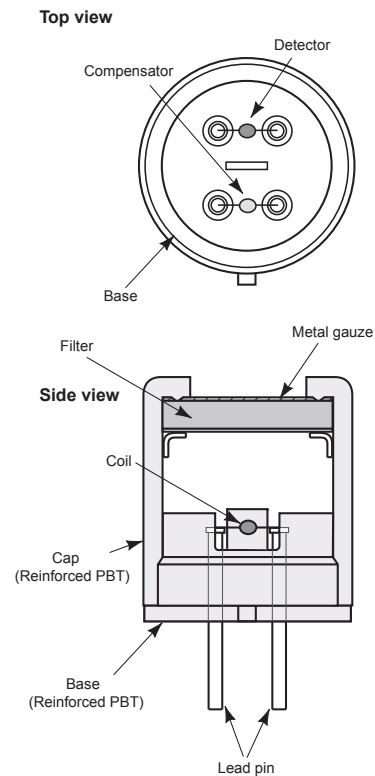

Fig. 1 - Sensor structure

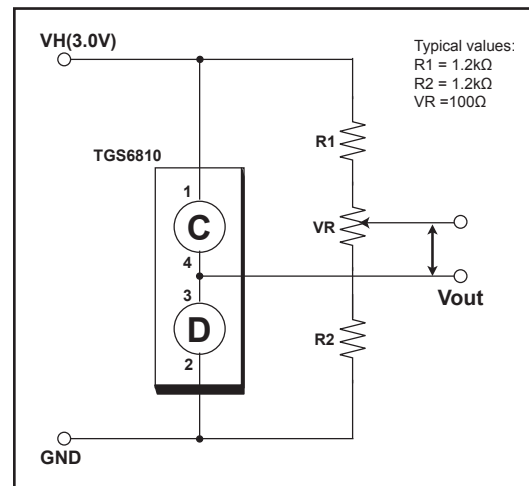

Fig. 2 - Basic measuring circuit

1-5 Circuit & operating conditions

The ratings shown below should be maintained at all times to insure stable sensor performance:

Item	Specification
Operating voltage	3.0V±0.1V DC/AC
Operating conditions	-10°C ~ +50°C. 95%RH (w/o dew condensation)
Storage conditions	-10°C ~ +60°C. 95%RH (w/o dew condensation)
Typical detection concentration	0 ~ 100%LEL of methane/iso-butane

1-6 Specifications NOTE 1

Item	Specification
Zero offset	-15 ~ +55mV
Output sensitivity (ΔV_{out})	10~18mV in 5000ppm methane
	5~11mV in 1800ppm iso-butane
Heater current	175mA (typical)
Heater power consumption	525mW (typical)

NOTE 1: Sensitivity characteristics are obtained under the following standard test conditions:

(Standard test conditions)

Temperature and humidity: 20 ± 2°C, 65 ± 5% RH

Circuit conditions: $V_H = 3.0 \pm 0.05V$ AC/DC

Preheating period: 30 seconds or more under standard circuit conditions

All sensor characteristics shown in this brochure represent typical characteristics. Actual characteristics vary from sensor to sensor and from production lot to production lot. The only characteristics warranted are those shown in the Specification table above.

1-7 Dimensions

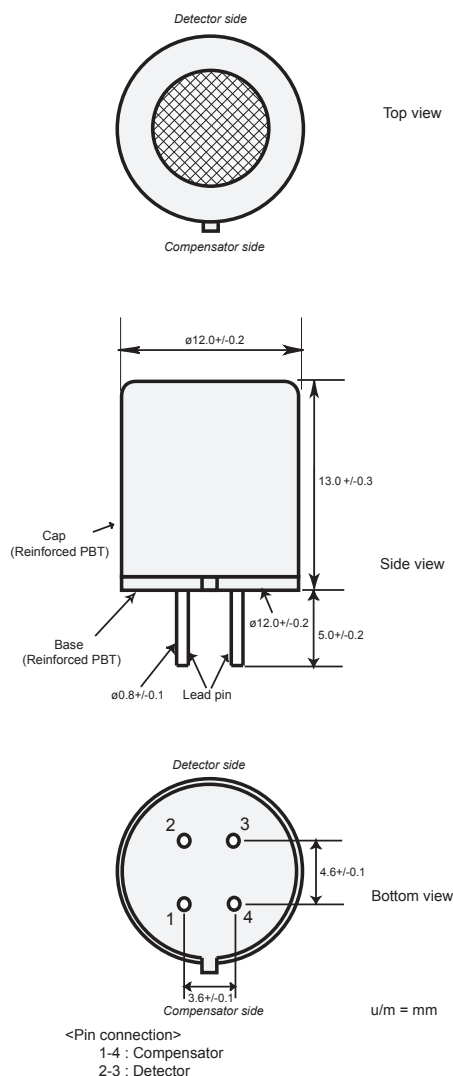

Fig. 3 - Sensor dimensions

Mechanical Strength:

The sensor shall have no abnormal findings in its structure and shall satisfy the above electrical specifications after the following performance tests:

Vibration - frequency: 10~150Hz, acceleration: 2G, duration: 10 times, direction: three dimensions

Drop test - drop onto a cement floor from a height of 250mm, repeated 5 times

2. Typical Sensitivity Characteristics

2-1 Sensitivity to various gases

Figure 4 shows the relative sensitivity of TGS6810-D00 to various gases. The Y-axis shows sensor output as a measure of sensitivity.

The sensitivity to ethanol, which may act as an interference gas, is very small.

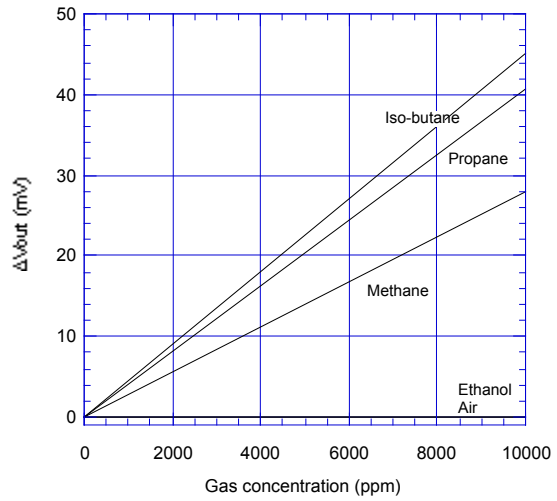

Fig. 4 - Sensitivity to various gases

2-2 Temperature dependency

Figure 5 shows the temperature dependency of TGS6810-D00 at 65%RH in 10%LEL of methane and LP gas. Since the temperature dependency of element (D) is compensated by element (C), the temperature dependency of sensor output in the range from -10°C to +70°C is very small.

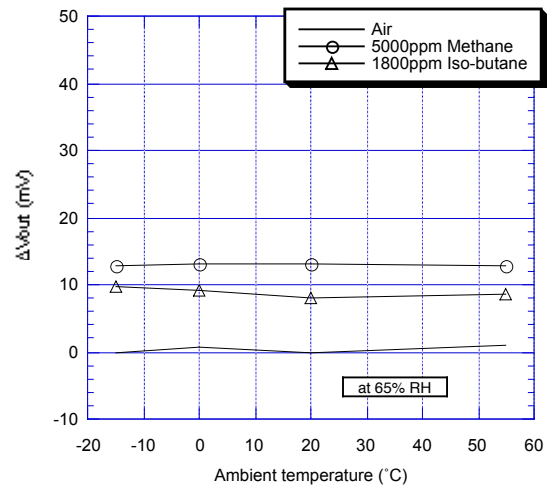

Fig. 5 - Temperature dependency

2-3 Humidity dependency

Figure 6 shows the relative humidity dependency of TGS6810-D00 under constant temperature of 20°C in 10%LEL of methane or LP gas. This data demonstrates that the humidity dependency of TGS6810-D00 is negligible as humidity varies.

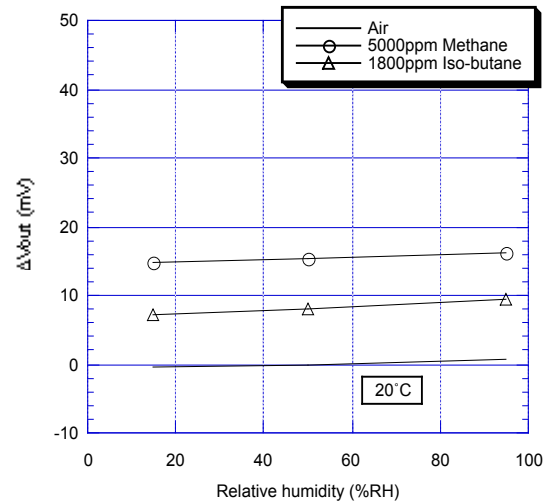

Fig. 6 -Humidity dependency

2-4 Heater voltage dependency

Figure 7 shows the change in the sensor output according to variations in the heater voltage (V_H).

Note that 3.0±0.1V as a heater voltage must be maintained because variance in applied heater voltage will cause the sensor's characteristics to be changed from the typical characteristics shown in this brochure.

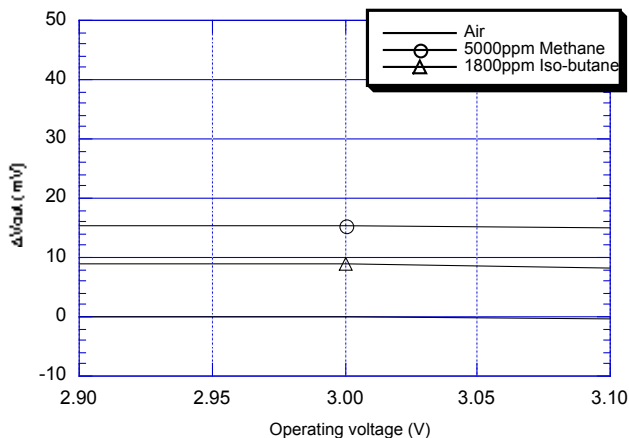

Fig. 7 - Heater voltage dependency

2-5 Gas response

Figure 8 shows the change pattern of sensor output (V_{out}) for TGS6810-D00 when the sensor is inserted into and later removed from gas.

As these charts display, the sensor's response speed to the presence of gas is extremely quick.

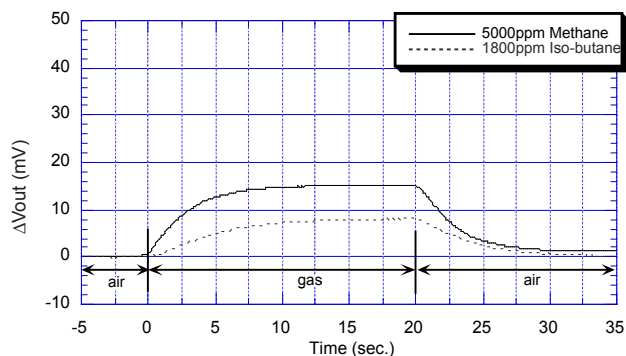

Fig. 8 - Gas response

2-6 Initial action

Figure 9 shows the initial action of the sensor output (V_{out}) for a sensor which is stored unenergized in normal air and later energized in clean air.

The sensor output increases sharply for the first seconds after energizing, regardless of the presence of gases, and then reaches a stable level according to the ambient atmosphere. Such behavior during the warm-up process is called "Initial Action".

Since this 'initial action' may cause a detector to alarm unnecessarily during the initial moments after powering on, it is recommended that an initial delay circuit be incorporated into the detector's design. This is especially recommended for intermittent-operating devices such as portable gas detectors.

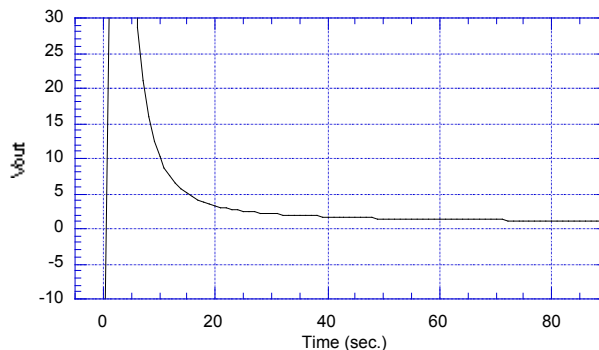

Fig. 9- Initial action

3. Reliability

3-1 Long-term characteristics

Figure 10 shows long-term stability of TGS6810-D00 as measured for more than 8 years. The sensor is first energized in normal air. Measurement for confirming sensor characteristics is conducted under standard test conditions. The Y-axis represents the sensor output (Vout) in air, 5000ppm of methane and 1800ppm of isobutane.

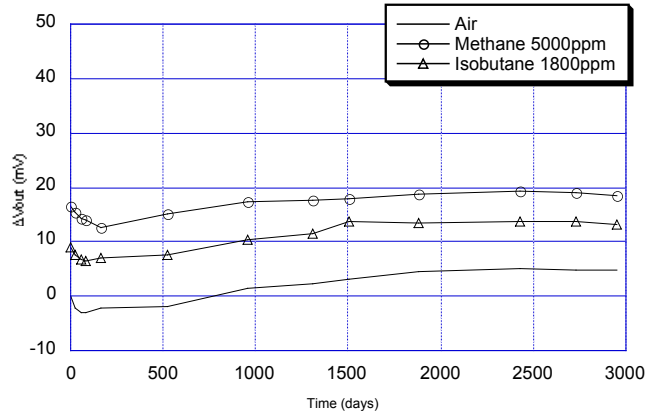

Fig. 10 - Long term characteristics

The sensor output is very stable over the test period.

3-2 Durability to hydrogen

Figure 11 shows the effect of long-term high concentration exposure to hydrogen gas. The initial point of the graph shows the value of sensor output prior to hydrogen exposure. After the initial measurement was taken, the sensor was exposed to 1% of H₂ for over 2000 hours. At each measurement point, the sensor was removed from H₂ gas and energized in normal air for 10 hours prior to measuring sensor output.

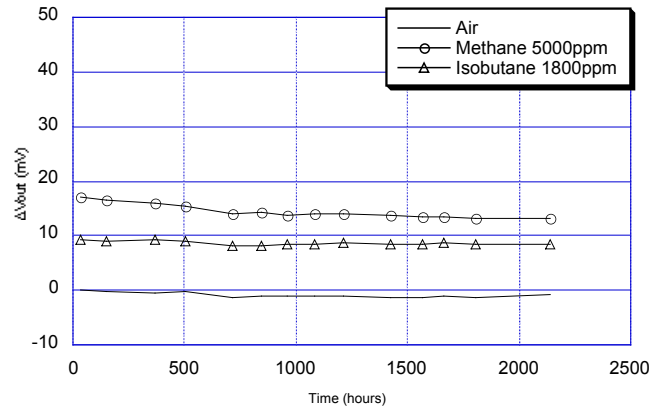

Fig. 11 - Durability to hydrogen

The data demonstrates that TGS6810-D00 shows stable characteristics after exposure to high concentrations of hydrogen.

3-3 Durability to sulphur dioxide

Figure 12 shows the effect on TGS6810-D00 of exposure to SO₂. The initial point of the graph shows the value of sensor output prior to SO₂ exposure. After the initial measurement was taken, the sensor was exposed to 25ppm of SO₂ for over 2400 hours in total. At each measurement point, the sensor was removed from SO₂ and energized in normal air for 10 hours prior to measuring the sensor output.

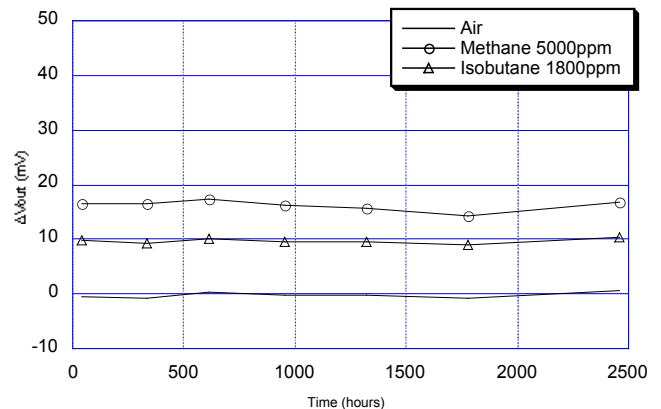

Fig. 12 - Durability to SO₂

The data demonstrates that TGS6810-D00 shows stable characteristics after exposure to SO₂.

3-4 Durability to nitrogen dioxide

Figure 13 shows the effect on TGS6810-D00 of exposure to NO₂. The initial point of the graph shows the value of sensor output prior to NO₂ exposure. After the initial measurement was taken, the sensor was exposed to 100ppm of NO₂ for over 2400 hours in total. At each measurement point, the sensor was removed from NO₂ and energized in normal air for 10 hours prior to measuring the sensor output after removal from NO₂.

The data demonstrates that TGS6810-D00 shows stable characteristics after exposure to NO₂.

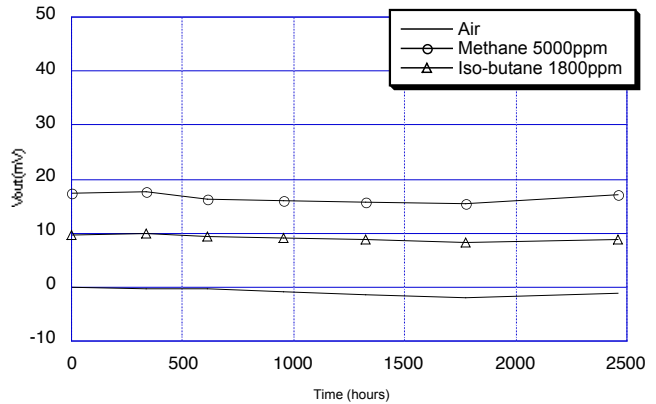

Fig. 13 - Durability to NO₂

3-5 Durability to HMDS

Figure 14 shows the effect on TGS6810-D00 of exposure to HMDS. The initial point of the graph shows the value of sensor output prior to HMDS exposure. After the initial measurement was taken, the sensor was exposed to 10ppm of HMDS for 24 hours (36 times the period specified in Item 5.3.13 of European Standard EN50194). At each measurement point, the sensor was removed from HMDS and energized in normal air for 1 hour prior to measuring sensor output.

This data demonstrates that TGS6810-D00 shows stable characteristics after exposure to HMDS.

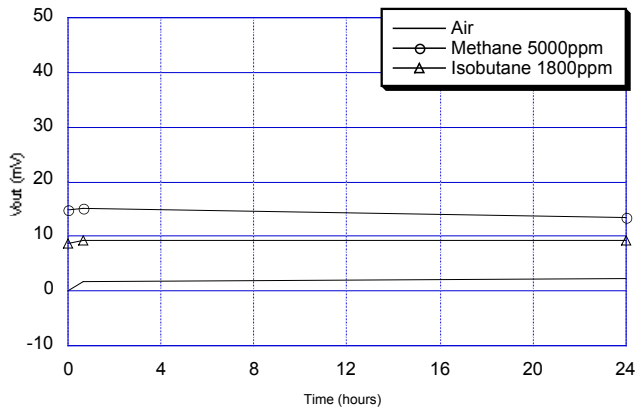

Fig. 14 - Durability to HMDS

3-6 Effects of Air Flow

Table 1 shows how the sensor is affected by airflows (refer to Fig. 15 for illustration of airflows in Table 1). This data demonstrates that there is no significant influence on the sensor by an air flow of 3.1 meters/sec.

Direction	Flow Rate	Fluctuation of output in air (mV)
1	3.0m/sec.	approx. ±0.5
2	3.0m/sec.	approx. ±0.5
3	3.0m/sec.	approx. ±1.0
4	3.0m/sec.	approx. ±1.0

Table 1 - Effects of air flow on output voltage

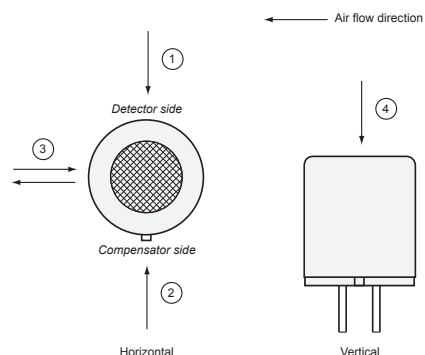

Fig. 15 - Air flow testing direction (ref. Table 1)

4 Cautions on Usage of Figaro Gas Sensors

4-1 Situations which must be avoided

1) Exposure to silicone vapors

If silicone vapors adsorb onto the sensor's surface, the sensing material will be coated, irreversibly inhibiting sensitivity. Avoid exposure where silicone adhesives, hair grooming materials, or silicone rubber/putty may be present.

2) Highly corrosive environment

High density exposure to corrosive materials such as H₂S, SO_x, Cl₂, HCl, etc. for extended periods may cause corrosion or breakage of the lead wires or heater material.

3) Contamination by alkaline metals

Sensor drift may occur when the sensor is contaminated by alkaline metals, especially salt water spray.

4) Contact with water

Sensor drift may occur due to soaking or splashing the sensor with water.

5) Freezing

If water freezes on the sensing surface, the sensing material would crack, altering characteristics.

6) Application of excessive voltage

If higher than specified voltage is applied to the sensor, the lead wires and/or sensor elements may be damaged or sensor characteristics may drift, even if no physical damage or breakage occurs.

7) Operation in zero/low oxygen environment

TGS6810 requires the presence of a certain amount of oxygen in its operating environment in order to generate a combustion reaction of gas on the sensor's surface. It cannot properly operate in a zero or low oxygen content atmosphere.

8) Excessive exposure to alcohol

If TGS6810-D00 is exposed to high concentrations of alcohol (such as 10,000ppm or more) for a long period, the filter may become saturated. In this case, the sensor would show a lower resistance in alcohol than indicated in Figure 4.

9) Vibration

Excessive vibration may result in zero drift or cause the sensor or lead wires to resonate and break. Usage of compressed air drivers/ultrasonic welders on

assembly lines may generate such vibration, so tests should be conducted to verify that there will be no influence on sensor characteristics.

10) Shock

Zero drift and breakage of lead wires may occur if the sensor is subjected to a strong shock. To avoid shock, please keep the sensor in the original packing foam during storage.

4-2 Situations to be avoided whenever possible

1) Water condensation

Light condensation under conditions of indoor usage should not pose a problem for sensor performance. However, if water condenses on the sensor's surface and remains for an extended period, sensor characteristics may drift.

2) Usage in high density of gas

Sensor performance may be affected if exposed to a high density of gas for a long period of time, regardless of the powering condition.

3) Storage for extended periods

When stored without powering for a long period, the sensor may show a reversible drift in resistance according to the environment in which it was stored. The sensor should be stored in a sealed bag containing clean air; do not use silica gel. *Note that as unpowered storage becomes longer, a longer preheating period is required to stabilize the sensor before usage.*

4) Long term exposure in adverse environment

Regardless of powering condition, if the sensor is exposed in extreme conditions such as very high humidity, extreme temperatures, or high contamination levels for a long period of time, sensor performance will be adversely affected.

5) Soldering

Ideally, sensors should be soldered manually. However, wave soldering can be done under the following conditions:

a) Suggested flux: rosin flux with minimal chlorine

b) Speed: 1-2 meters/min.

c) Preheating temperature: 100±20°C

d) Solder temperature: 250±10°C

e) Up to two passes through wave soldering machine allowed

Results of wave soldering cannot be guaranteed if conducted outside the above guidelines since some flux vapors may cause drift in sensor performance similar to the effects of silicone vapors.

Figaro USA Inc. and the manufacturer, Figaro Engineering Inc. (together referred to as Figaro) reserve the right to make changes without notice to any products herein to improve reliability, functioning or design. Information contained in this document is believed to be reliable. However, Figaro does not assume any liability arising out of the application or use of any product or circuit described herein; neither does it convey any license under its patent rights, nor the rights of others.

Figaro's products are not authorized for use as critical components in life support applications wherein a failure or malfunction of the products may result in injury or threat to life.

Contact:

UNITRONIC AG
Mündelheimer Weg 9
40472 Düsseldorf

Telefon 0211 / 95 110
Telefax 0211 / 95 11 111
info@unitronic.de

