

Technical Information for Carbon Monoxide Sensors

Figaro’s TGS5141 is a battery operable electrochemical sensor which uses a unique electrolyte that eliminates the need for a water reservoir. By eliminating the water reservoir used in TGS5042, the comparative size of TGS5141 is reduced to just 10% of TGS5042. With its ultra compact size, this sensor is the ideal choice for size oriented applications such as portable CO detectors, small residential CO detectors, and multi-sensor fire detectors. OEM customers will find individual sensor data printed on each sensor in bar code form, enabling users to skip the costly gas calibration process and allowing for individual sensor tracking.



<i>Specifications</i>	<i>Page</i>
Features.....	2
Applications.....	2
Structure.....	2
Basic Measuring Circuit.....	2
Operating Conditions & Specifications.....	2
Mechanical strength.....	3
Dimensions.....	3
<i>Operation Principle</i>	4
<i>Basic Sensitivity Characteristics</i>	
Sensitivity to Various Gases.....	5
Temperature and Humidity Dependency.....	5
Gas Response Pattern.....	6
Repeatability.....	6
Influence of Storage.....	6
Normal Operation Test.....	7
Sensitivity Test.....	7
<i>Reliability</i>	
Interference Gas Test.....	8
Long-Term Stability.....	9
Corrosion Test.....	9
Variable Ambient Temperature Test.....	9
Humidity Test.....	10
Stability Tests.....	11
Dust Test.....	12
<i>Marking</i>	12
<i>Cautions</i>	13
<i>Appendix - Lead configuration</i>	14

IMPORTANT NOTE: OPERATING CONDITIONS IN WHICH FIGARO SENSORS ARE USED WILL VARY WITH EACH CUSTOMER’S SPECIFIC APPLICATIONS. FIGARO STRONGLY RECOMMENDS CONSULTING OUR TECHNICAL STAFF BEFORE DEPLOYING FIGARO SENSORS IN YOUR APPLICATION AND, IN PARTICULAR, WHEN CUSTOMER’S TARGET GASES ARE NOT LISTED HEREIN. FIGARO CANNOT ASSUME ANY RESPONSIBILITY FOR ANY USE OF ITS SENSORS IN A PRODUCT OR APPLICATION FOR WHICH SENSOR HAS NOT BEEN SPECIFICALLY TESTED BY FIGARO.



TGS5141 is a UL recognized component in accordance with the requirements of UL2034. Please note that component recognition testing has confirmed long term stability in 15ppm of carbon monoxide; other characteristics shown in this brochure have not been confirmed by UL as part of component recognition.

1. Specifications

1-1 Features

- * Ultra compact size
- * Battery operable
- * High repeatability/selectivity to carbon monoxide
- * Linear relationship between CO gas concentration and sensor output
- * Simple calibration
- * Long life
- * UL recognized component
- * Meets UL2034, EN50291, and EN54-31 requirements

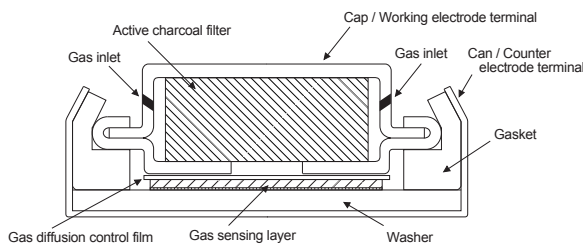

Figure 1 - Sensor structure

1-2 Applications

- * Residential and commercial CO detectors
- * Fire detection

1-3 Structure

Figure 1 shows the structure of TGS5141. The gas sensing layer is sandwiched between a stainless steel washer (counter electrode) and a stainless steel cap (working electrode), together with gas diffusion control stainless film and backing layers. This assembly is placed in the compartment of the stainless steel can. A charcoal filter is installed inside the stainless steel cap.

1-4 Basic measuring circuit

Figure 2 shows the basic measuring circuit of TGS5141. The sensor generates a minute electric current which is converted into sensor output voltage (V_{out}) by an op-amp/resistor (R_1) combination.

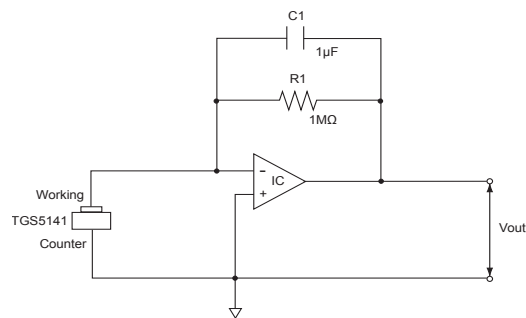

Figure 2 - Basic measuring circuit
(Including equivalent circuit)

Figaro recommends the following electrical parts:

- R1 : 1MΩ
- C1 : 1μF
- IC : AD708

An additional resistor or FET is required to prevent polarization of the sensor when circuit voltage is off.

NOTE: When voltage is applied to the sensor output terminal, the sensor may be damaged. Voltage applied to the sensor should be strictly limited to less than $\pm 10\text{mV}$.

1-5 Operating conditions & specifications (Table 1)

Item	Specification
Model number	TGS5141-P00
Target gases	Carbon monoxide
Typical detection range	0 ~ 5,000ppm
Output current in CO	1.2~3.2nA/ppm
Baseline offset(*1)	$< \pm 10\text{ppm}$ equivalent
Operating temperature	-10°C ~ +50°C (continuous) -20°C ~ +60°C (intermittent)
Operating humidity	10 ~ 95%RH (no condensation)
Response time (T90)	within 60 seconds
Storage conditions	-10°C ~ +50°C (continuous) -20°C ~ +60°C (intermittent)
Weight	approx. 2.5g
Standard test conditions	20 \pm 2°C, 40 \pm 10%RH

NOTE 1: Represents sensor output in air under operating conditions

Table 1 - Operating conditions and specifications

1-6 Mechanical strength

Sensor samples were subjected to the following test conditions as specified by UL2034. The test results demonstrate that the sensor possesses sufficient mechanical strength for meeting UL requirements without abnormal findings in its structure and with its electrical specifications maintained after these tests.

Vibration - amplitude - 0.25mm, frequency - 35Hz, duration - 4 hours, x-y-z direction

Drop - height - 2.1m, repeat 5 times

1-7 Dimensions (see Fig. 3)

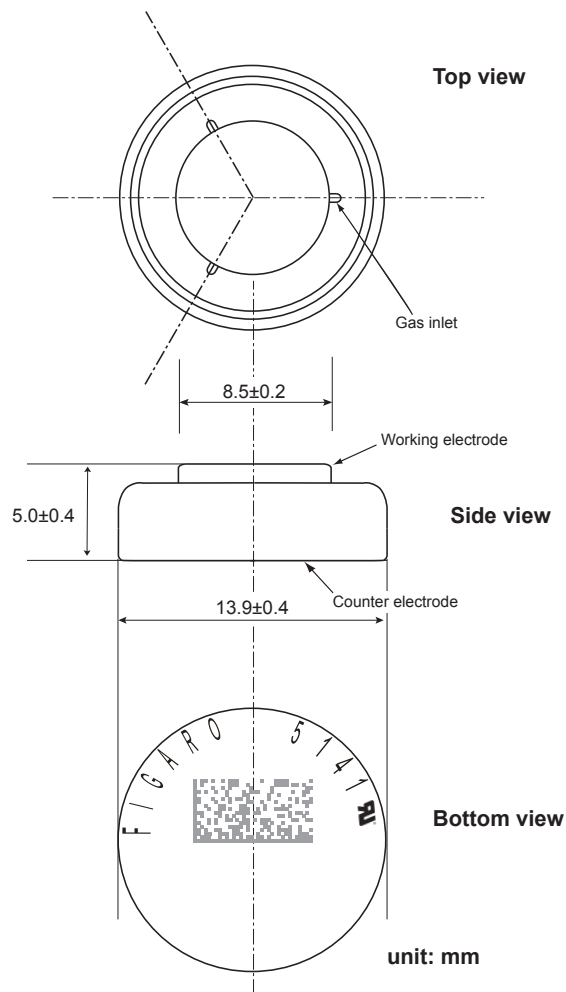

Figure 3 - Dimensions

All sensor characteristics shown in this brochure represent typical characteristics. Actual characteristics vary from sensor to sensor and from production lot to production lot. The only characteristics warranted are those shown in the Specification.

2. Operation Principle

The operation principle of TGS5141 is basically identical to that of a fuel cell. When CO passes through the gas permeable diffusion membrane and reaches the working electrode, protons and electrons are generated as part of a CO oxidization reaction (see equation 1). By creating a short circuit between the working and counter electrodes with external wiring, electrons and protons on the working electrode move to the counter electrode through the external wiring and through the proton conductor respectively. The proton then reacts with oxygen on the counter electrode as shown in equation 2. The total reaction is expressed as shown in equation 3.

A linear relationship exists between the sensor's electric current and CO concentration (see equation 4). By calibrating the sensor with a known concentration of CO gas, the output current of the sensor can then be used to quantitatively determine CO concentration.

Since, unlike conventional dry batteries, there is no consumption of active materials or of the electrodes, TGS5141 possesses excellent long-term stability for its output signal and enables maintenance-free operation. Furthermore, the sensor's self-generating output current makes it ideal for usage in battery-operated CO detectors.

Working electrode (Anodic reaction)

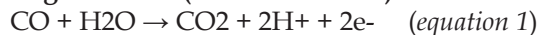

Counter electrode (Cathodic reaction)

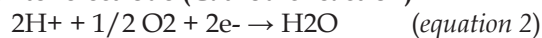

Total reaction

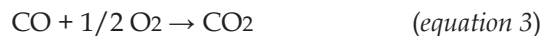

Theoretical output current value

$$I = F \times (A/\sigma) \times D \times C \times n \quad (\text{equation 4})$$

where:

F : Faraday constant

A: Surface area of diffusion film

D: Gas diffusion co-efficient

C: Gas concentration

σ : Thickness of diffusion film

n: Number of reaction electrons

Figure 4 - Operation principle

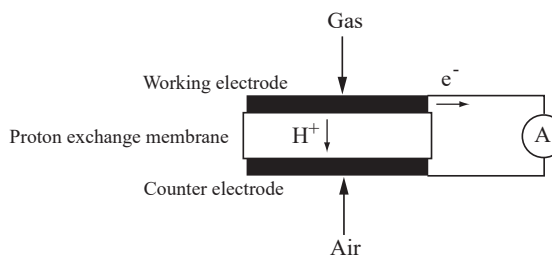

Figure 5 - Schematic diagram of TGS5141 operating principle

3. Basic Sensitivity Characteristics

3-1 Sensitivity to various gases

Figure 6 shows the sensor's sensitivity to various gases. The Y-axis shows output current ($I_{out}/\mu A$) in each gas. The output current is linear to CO concentration, with a deviation of less than $\pm 5\%$ in the range of 0~1000ppm. Cross sensitivity data for other gases than those in Figure 6 are tabulated in Table Y.

Gas		Concentration	CO equivalent
Hydrogen		1000ppm	500ppm
Methane	Heptane	1000ppm	<30ppm
Butane	IPA		
Ethanol	Freon R22		
HMDS (Si vapor)	Acetone		
Toluene	Cyclohexane		
Trichloroethane	CO ₂	200ppm	<30ppm
NO ₂	Ethylene		
Formaldehyde	Ammonia		
Xylene	SO ₂		
Acetic acid	Ethyl acetate		
Acetylene		200ppm	360ppm

Note: The figures in this table are typical values and should not be used as a basis for cross calibration. Cross sensitivity for various gases may not be linear and should not be scaled. All data based on a 4 minute exposure. For some gases, filter saturation and gas breakthrough may occur if gas is applied for a longer time period.

3-2 Temperature and humidity dependency

Figure 7a shows the temperature dependency of TGS5141 under a constant humidity of 50%RH. The Y-axis shows the ratio of output current in 400ppm of CO at various temperatures (I) to the output current in 400ppm of CO at 20°C/50%RH (I_0). Temperature dependency is based on the difference in the catalytic reaction rate on the electrodes, and it can be simply compensated by utilizing a thermistor. This linear relationship between I/I_0 and CO concentration is constant regardless of CO concentration range, according to the sensor's operating principle.

Figure 7b shows the humidity dependency of TGS5141 under constant temperatures of 20°C and 50°C. The Y-axis shows the ratio of output current in 400ppm of CO at various relative humidities (I) to the output current in 400ppm of CO at 20°C/50%RH (I_0). This data demonstrates that humidity dependency is negligible as temperature varies.

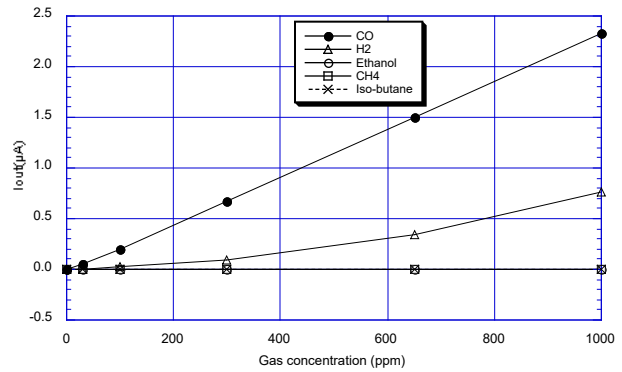

Figure 6 - Sensitivity to various gases

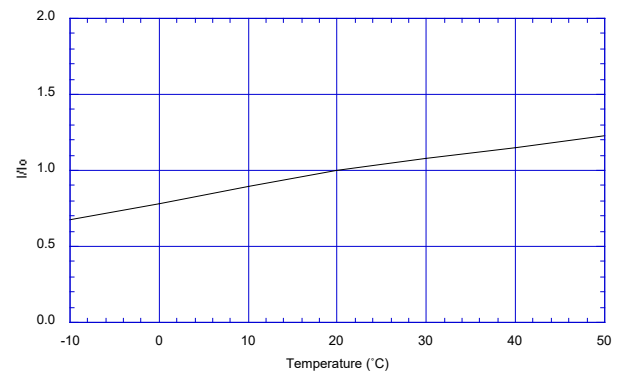

Figure 7a - Temperature dependency at 400ppm CO/50%RH (I_0 =sensor output current at 20°C)

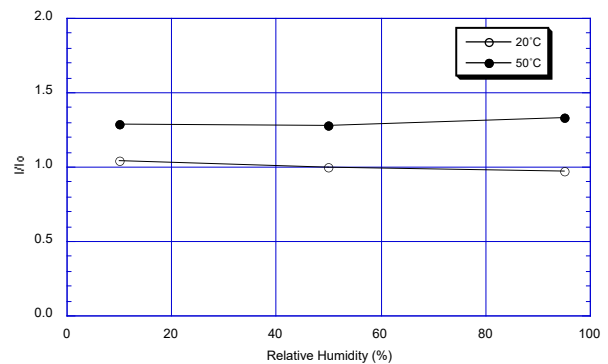

Figure 7b - Humidity dependency at 400ppm CO (I_0 =sensor output current at 50%RH)

3-3 Gas response pattern

Figure 8 shows the gas response pattern of the output signal when the sensor is placed into 30, 70, 150 and 400ppm of CO and then returned to normal air. The response time to 90% of the saturated signal level is within 60 seconds, and the recovery of the signal back to 90% of the base level is within 120 seconds. This data demonstrates that TGS5141 possesses sufficient response speed for meeting UL requirements for CO detectors.

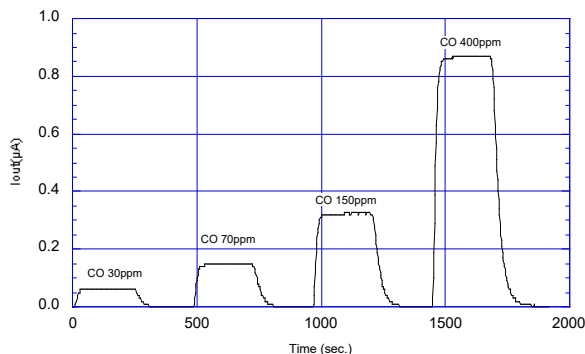

Figure 8 - Response pattern

3-4 Repeatability

Figure 9 shows the pattern of the output signal when the sensor is repeatedly exposed to 400ppm of CO at a constant interval of 240 seconds. The data demonstrates extremely high reproducibility of the output signal, the deviation being less than $\pm 5\%$.

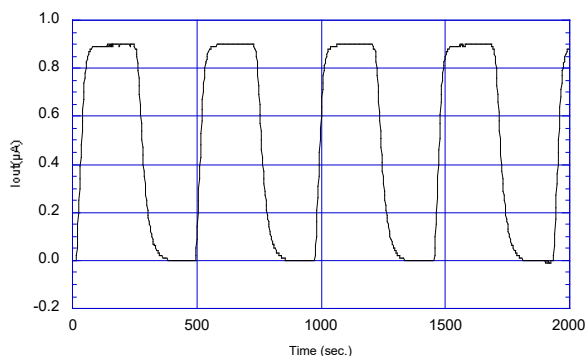

Figure 9 - Repeatability (in 400ppm of CO)

3-5 Influence of storage

Figure 10 shows the initial action of the sensor's output current signal in fresh air. For the purpose of this test, sensors were stored for more than six months under two separate conditions between the working and counter electrodes: in short-circuited condition, and in open-circuit condition. The chart illustrates the behavior of sensor output current for each group just after installation into the operating circuit. The output current signal of sensors stored in a short-circuited condition reaches its saturated level quickly, while those stored with an open-circuit exhibit much slower behavior.

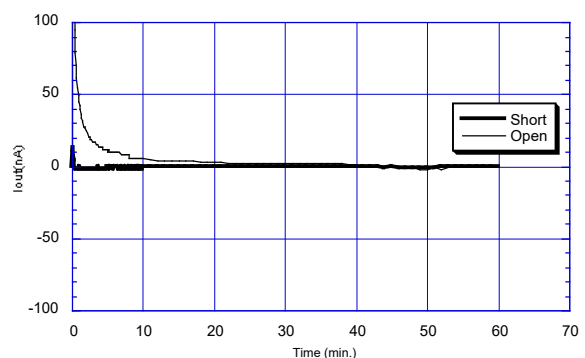

Figure 10 - Influence of storage (in fresh air)

Since sensors are shipped in an open-circuit condition, stabilization time of one hour (typical) is recommended after mounting on a PCB that includes an anti-polarization circuit (see *Item 2-4 in Application Notes for TGS5xxx Series*). If no antipolarization circuit is used, it is necessary to wait for about one hour after powering the circuit. One hour of powering is required, regardless of when the sensor is placed into the detector circuit.

3-6 Normal operation test

Figure 11a shows the result of the “Normal Operation Test” required by UL2034 where the sensor is exposed to 600ppm of CO for 12 hours at 20°C/40%RH. Stable output current signal can be seen throughout the exposure.

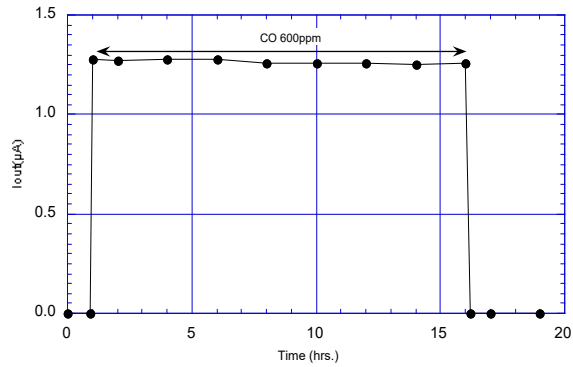

Figure 11a - Normal operation test (CO 600±30ppm for 12 hours at 20°C/40%RH)

In addition, Figure 11b shows the CO sensitivity characteristics of the sensor before, during, and after the Normal Operation Test, demonstrating that TGS5141 is hardly influenced by exposure to high concentrations of CO.

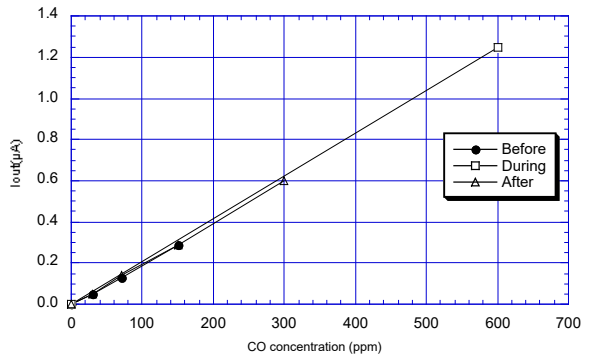

Figure 11b - Normal operation test (20°C/40%RH)

3-7 Sensitivity test

Figure 12a shows the results of the “Sensitivity Test” as required by UL2034. Under this test, the sensor was exposed to 30, 70, 150 and 400ppm of CO at 20°C/40%RH. The period of exposure was varied by concentration, corresponding with the maximum time in which a CO detector should generate an alarm for the subject concentration. Throughout the test exposures, TGS5141 displayed a reasonable and stable output current signal.

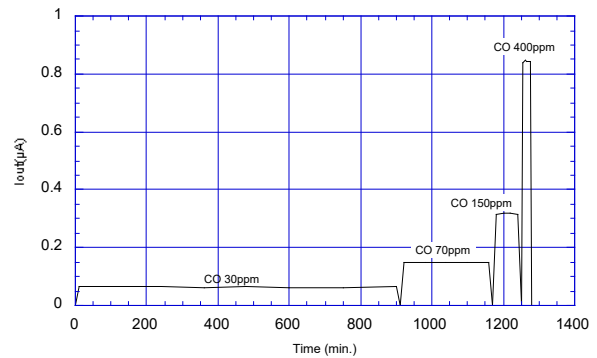

Figure 12a - Sensitivity test (20°C/40%RH)

In addition, Figure 12b indicates the CO sensitivity characteristics of the sensor before, during, and after the Sensitivity Test, demonstrating the excellent reproducibility of TGS5141's CO sensitivity characteristics.

4. Reliability

Tests conducted in this section demonstrate that TGS5141 can meet the requirements of various testing standards without incurring adverse long term effects from such tests.

4-1 Interference gas test

Figure 13a shows the results of testing the TGS5141 sensor for durability against various interference gases as specified by UL2034. The test was conducted by exposing the sensor to each gas shown in Figure 13a (starting with CO 30ppm) for two hours, then removing the sensor to fresh air for just one hour, and followed by inserting the sensor into the next gas. This procedure was repeated for the full range of gases shown in Figure 13a.

Because the sensor is exposed to each of the test gases consecutively, to some small extent the effect of the previous test gas may affect subsequent tests for a short period. However, despite the short-term effects of such gases remaining after exposure, the sensor still shows significantly less sensitivity to each test gas when compared to 30ppm of CO, and CO sensitivity remains unaffected.

In addition, Figure 13b shows the CO sensitivity characteristics of the sensor before and after this test, further demonstrating the excellent reproducibility of the CO sensitivity characteristics of TGS5141, demonstrating its durability against the interference gases listed in the requirements of UL2034.

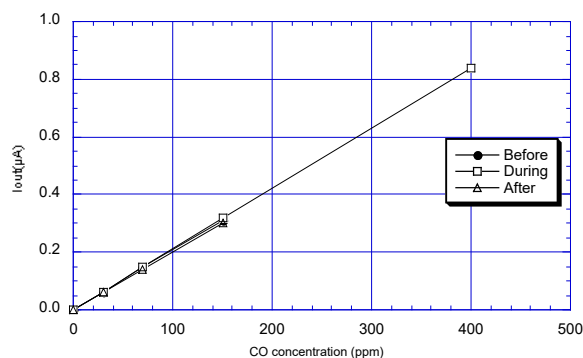

Fig. 12b - Sensitivity test (20°C/40%RH)

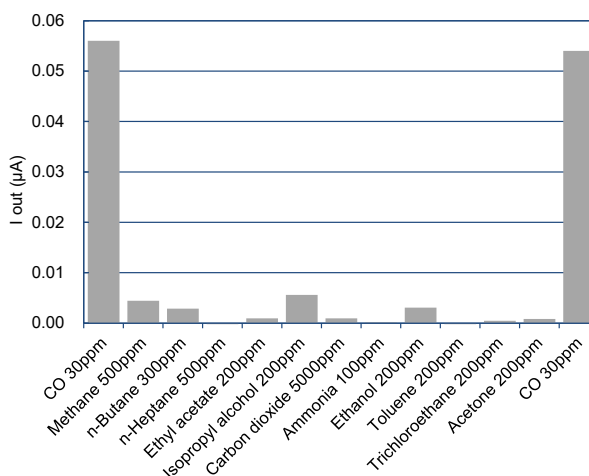

Figure 13a - Interference gas test (20°C/40%RH)

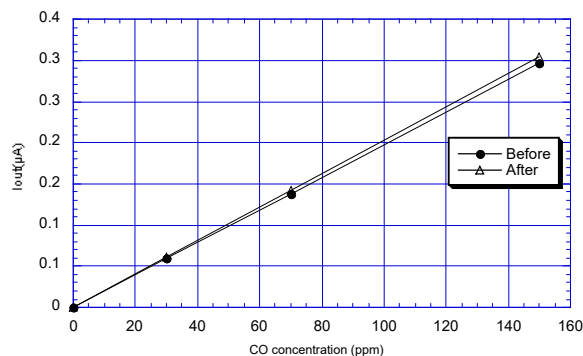

Figure 13b - Interference gas test (20°C/40%RH)

4-2 Long-term stability

Figure 14 shows long-term stability data for TGS5141. Test samples were stored in natural clean air under a short-circuit condition and measured at various intervals as dictated by the standard test conditions of UL2034. The Y-axis shows the ratio of output current in 300ppm of CO at any point in time (I) over output current in 300ppm of CO on the first day of the test (I₀). This chart demonstrates very stable characteristics for more than 700 days.

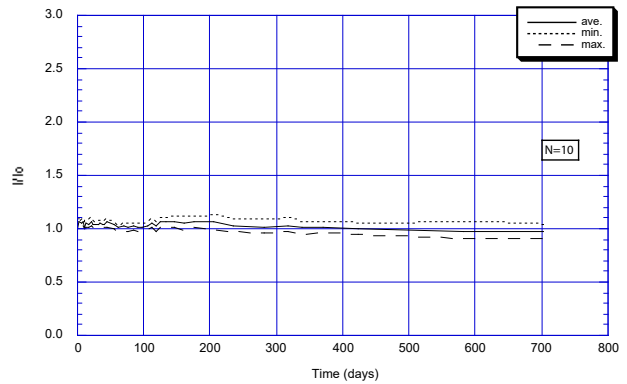

Figure 14 - Long term stability

4-3 Corrosion test

To demonstrate the durability of TGS5141 against corrosion, samples were subjected to test conditions called for by UL2034-Corrosion Test. Over a three-week period, a mixture of 100ppb of H₂S, 20ppb of Cl₂, and 200ppb of NO₂ was supplied to the sensors at a rate sufficient to achieve an air exchange rate of five times per hour. Figure 15 shows the CO sensitivity characteristics before and after exposure in the above conditions, demonstrating that TGS5141 is hardly influenced by such corrosive gases. In addition, the sensor's stainless steel housing did not show any sign of corrosion as a result of this test.

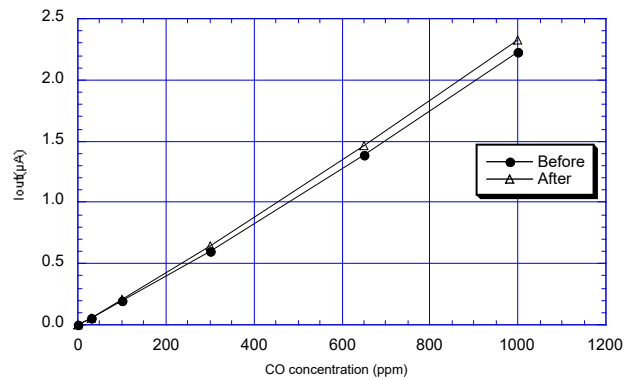

Figure 15 - Durability against corrosion

4-4 Variable ambient temperature test

To demonstrate the ability of TGS5141 to withstand the effects of high and low temperature, the “Variable Ambient Temperature Test” of UL2034 was conducted.

(1) Operation in high and low temperature test

Figure 16a shows the results for the “Operation in High and Low Temperature Test” of UL2034. The sensor was exposed to environments of 0°C/15%RH and 49°C/40%RH for at least three hours each, with measurements taken before and during the exposure in accordance with the test conditions of UL2034. By plotting the output current values from these test measurements atop the data taken prior to this test at a constant 50%RH (representing standard temperature dependency), it can be seen that the test data are still in line with data taken at a constant RH. The conclusion which can be drawn is that, regardless of exposure to extremes of temperature and humidity, the sensor's output is not affected by humidity. As a result, TGS5141 can meet the requirements of UL2034 by utilizing a simple temperature compensation method.

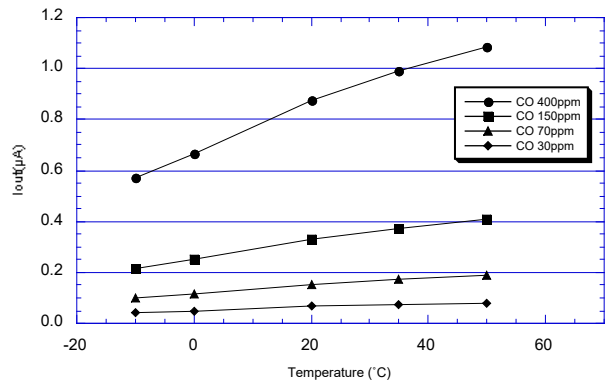

Figure 16a - Operation in high and low temperature (all data at 50%RH except test points)

(2) Effect of shipping and storage

To verify the effects of shipping and storage, the sensor was tested under the conditions of UL2034. Test samples in a short-circuited condition were subjected to 70°C for 24 hours, allowed to cool to room temperature for 1 hour, subjected to -40°C for 3 hours, and then allowed to warm up to room temperature for 3 hours. Figure 16b shows the CO sensitivity characteristics before and after the test, demonstrating that TGS5141 meets the requirement of UL2034.

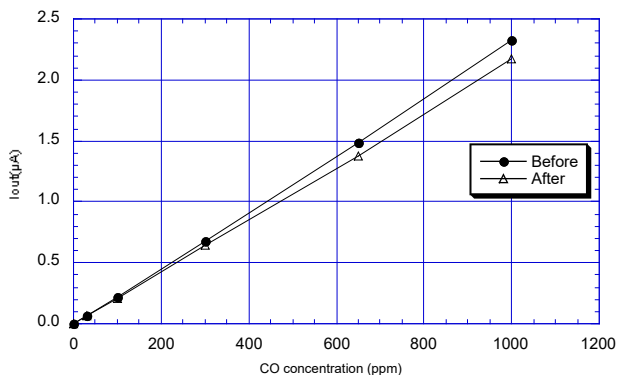

Figure 16b - Effects of shipping and storage

4-5 Humidity test

Figure 17a shows the results of testing the sensor under UL2034. The sensor was exposed in an atmosphere of 52±3°C/95±4%RH for a period of 168 hours, returned to normal air for 2 days, then followed by 168 hours exposure at 22±3°C/10±3%RH. CO sensitivity measurements were taken during exposure to high and low humidity conditions. The graph shows before and after exposure to high and low humidity conditions, taken at 20°C/50%RH. The data demonstrates the stable characteristics in both low and high humidity conditions.

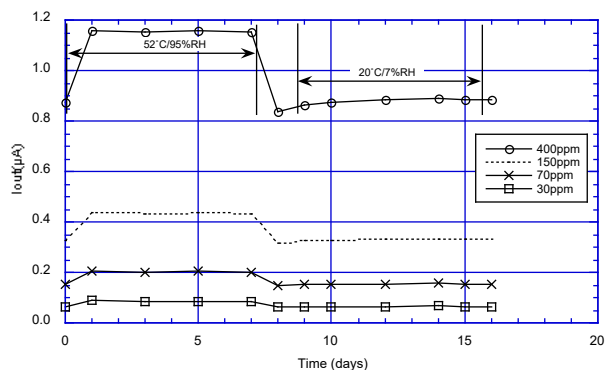

Figure 17a - Humidity test

Figure 17b shows data taken prior to the above test at a constant relative humidity of 50%. These curves represent the typical temperature dependency of the sensor. When plotting measurements taken at the environmental extremes specified on UL2034 (52±3°C/95±4%RH and 22±3°C/10±3%RH) onto the temperature dependency curves, it can be seen that measurements taken at these extreme conditions still fall in line with the temperature dependency curve derived prior to testing. The conclusion which can be drawn is that, regardless of exposure to extremes of temperature and humidity, the sensor's output is not affected by humidity. As a result, TGS5141 can meet the requirements of UL2034 by utilizing a simple temperature compensation method.

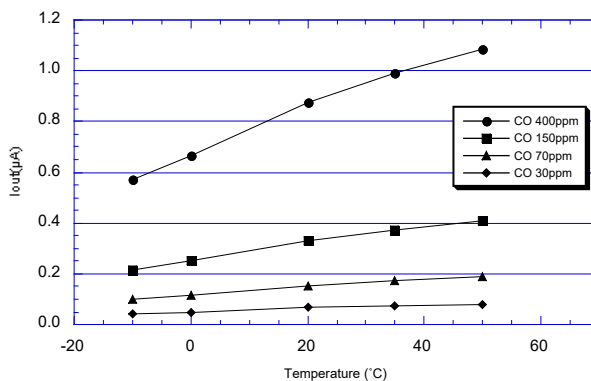

Figure 17b - Humidity test (all data at 50%RH except test points)

4-6 Stability test

(1) False alarm test

To show the sensor's behavior under continuous low level exposure to CO, samples were tested against the procedure detailed in UL2034--Stability Test. Test samples were exposed to 30ppm of CO continuously for a period of 30 days under standard circuit conditions. Figure 18 shows the CO sensitivity characteristics before and after the exposure test, demonstrating that detectors using TGS5141 will not give a false alarm as a result of continuous low level CO exposure.

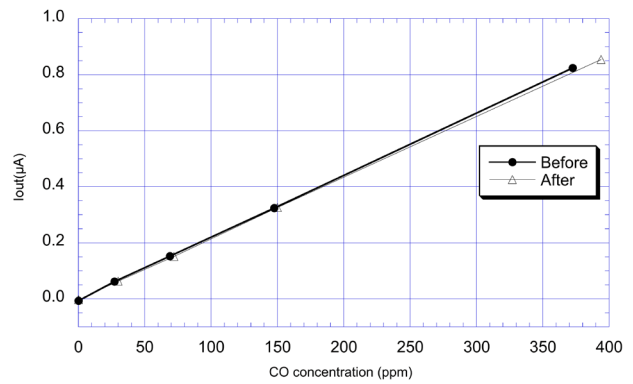

Figure 18 - False alarm test

(2) Temperature cycle test

In accordance with UL2034--Stability Test, test samples were exposed to ten cycles (<1 hour and >15 minutes) of temperature from 0°C/100%RH to 49°C/40%RH. Figure 19 shows CO sensitivity characteristics before and after the cycle test, demonstrating that TGS5141 is hardly influenced by the extreme conditions of the temperature cycle test.

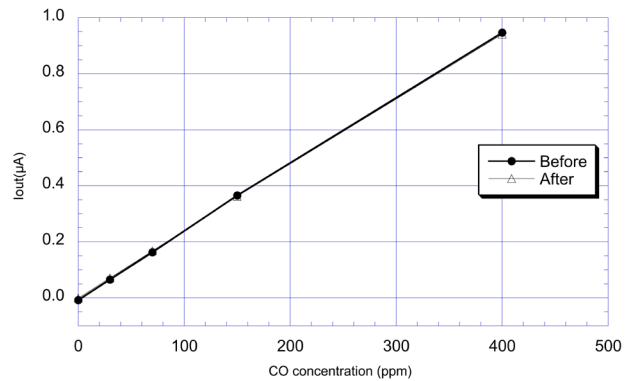

Figure 19 - Temperature cycle test

6. Cautions

6-1 Situations which **must** be avoided

1) *Disassembling the sensor*

Under no circumstances should the sensor be disassembled, nor should the sensor can and/or cap be deformed.

2) *Contamination by alkaline metals*

Sensor characteristics may be significantly changed when the sensor is contaminated by alkaline metals, especially salt water spray.

3) *Exposure to high concentration of basic (non-acidic) gases*

Sensor characteristics may be irreversibly changed by exposure to high concentrations of basic gases such as ammonia. Avoid long term exposure to or use of packing materials that may generate basic gases.

4) *Exposure to certain VOCs*

Avoid prolonged exposure to certain VOCs such as styrene (commonly used in blister packs and packing trays) and α -pinene (found in some kinds of printing inks). Off-gassing from such VOCs may cause irreversible changes to sensor characteristics. Avoid packing the sensor or products incorporating the sensor in a tightly closed container in which such VOC gases may be present. It is strongly recommended to conduct a test to see if there would be any adverse influence by packing materials on sensor characteristics. If the sensor is excessively exposed to other organic vapors such as alcohols or acetone, these gases may cause temporary change of cross sensitivity characteristics.

5) *High temperature exposure*

At temperatures of 80°C or higher, the sensing membrane may deteriorate, resulting in irreversible change of sensor characteristics.

6) *Contact with water*

Sensor characteristics may be changed due to soaking or splashing the sensor with water.

7) *Application of excessive voltage*

If higher than specified voltage is applied to the sensor, breakage may occur or sensor characteristics may drift, even if no physical damage or breakage occurs. Do not use the sensor once excessive voltage is applied.

6-2 Situations to avoid whenever possible

1) *Exposure to silicone vapors*

Avoid exposure of sensor where silicone adhesives, hair grooming materials, or silicone rubber/putty may be present. Silicone vapors may cause clogging of the gas diffusion route.

2) *Dew condensation*

If severe dew condensation occurs for a long period inside of the sensor or on the sensor surface, it may cause

clogging of gas diffusion route or deterioration of the sensing membrane. Mild dew condensation which occurs in normal indoor air would not cause any significant damage.

3) *Exposure to hydrogen sulfide or sulfuric acid gas*

If the sensor is exposed to hydrogen sulfide or sulfuric acid gas, sensor components such as the gas diffusion film, can, and cap may be corroded, resulting in the sensor damage.

4) *Vibration and shock*

Vibration and shock may cause an open or short circuit inside the sensor.

5) *Dust and oil mist*

Extremely high concentrations of dust or oil mist may cause clogging of the sensor's internal structure. When such conditions are expected to be encountered, installation of an external air filter is recommended.

6) *Flux for soldering*

Manual soldering is recommended since high concentrations of flux may affect sensor characteristics when the sensor is soldered by wave soldering. When wave soldering is used, a test should be conducted before production starts to see if there would be any influence to sensor characteristics. Please refer to *Item 7-3 of Application Notes for TGS5xxx Series* for advice on manual soldering conditions.

6-3 Additional cautions for installation

This sensor requires the existence of oxygen in the operating environment to function properly and to exhibit the characteristics described in this brochure. The sensor will not operate properly in a zero oxygen environment.

Figaro USA Inc. and the manufacturer, Figaro Engineering Inc. (together referred to as Figaro) reserve the right to make changes without notice to any products herein to improve reliability, functioning or design. Information contained in this document is believed to be reliable. However, Figaro does not assume any liability arising out of the application or use of any product or circuit described herein; neither does it convey any license under its patent rights, nor the rights of others.

Figaro's products are not authorized for use as critical components in life support applications wherein a failure or malfunction of the products may result in injury or threat to life.

APPENDIX

TGS5141-P00 Lead Configuration

Leads are connected to sensor electrodes when the sensors are shipped.

Stainless steel (SUS) pin version (Fig. 22)

Solid SUS pins enable the sensor to be more easily mounted and/or directly soldered onto a PCB.

The height from the PCB to the sensor should be 0.6 mm or more to ensure sufficient electrical insulation from the PCB.

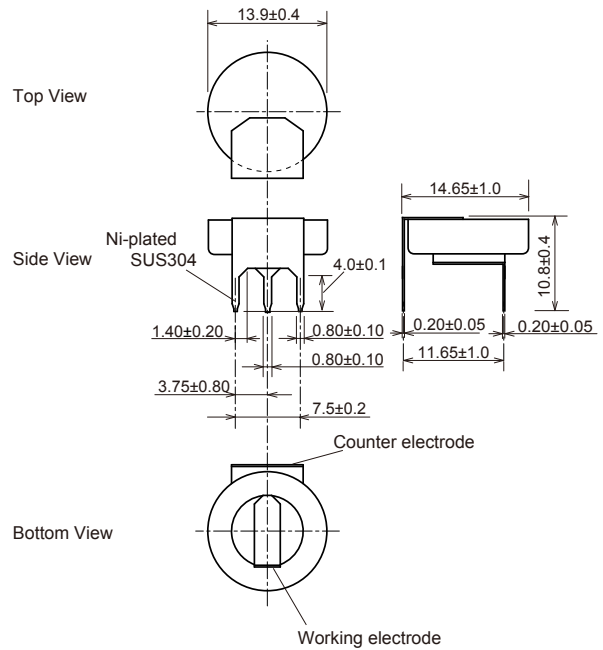

Figure 22 - Dimensions (w/lead pins) Unit : mm

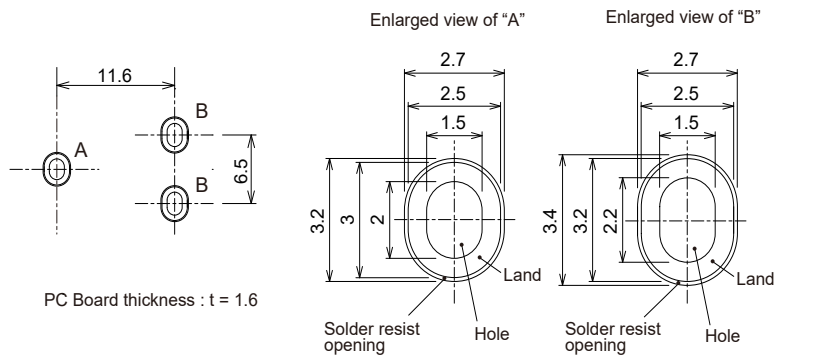

Figure 23 - Foot print example Unit : mm

Before purchasing this product, please read the Warranty Statements shown in our webpage by scanning this QR code.



https://www.figaro.co.jp/en/pdf/Limited_Warranty_en.pdf

FIGARO ENGINEERING INC.
 1-5-11 Senba-nishi
 Mino, Osaka 562-8505 JAPAN
 Phone: (81)-727-28-2045
 email: figaro@figaro.co.jp
 www.figaro.co.jp